

## Nokia ONT

# XS-2426G-B Product Guide

**3FE-49546-AAAA-TCZZA**

**Issue 1**

**December 2021**

---

**Legal notice**

Nokia is committed to diversity and inclusion. We are continuously reviewing our customer documentation and consulting with standards bodies to ensure that terminology is inclusive and aligned with the industry. Our future customer documentation will be updated accordingly.

---

This document includes Nokia proprietary and confidential information, which may not be distributed or disclosed to any third parties without the prior written consent of Nokia.

This document is intended for use by Nokia's customers ("You"/"Your") in connection with a product purchased or licensed from any company within Nokia Group of Companies. Use this document as agreed. You agree to notify Nokia of any errors you may find in this document; however, should you elect to use this document for any purpose(s) for which it is not intended, You understand and warrant that any determinations You may make or actions You may take will be based upon Your independent judgment and analysis of the content of this document.

Nokia reserves the right to make changes to this document without notice. At all times, the controlling version is the one available on Nokia's site.

No part of this document may be modified.

NO WARRANTY OF ANY KIND, EITHER EXPRESS OR IMPLIED, INCLUDING BUT NOT LIMITED TO ANY WARRANTY OF AVAILABILITY, ACCURACY, RELIABILITY, TITLE, NON-INFRINGEMENT, MERCHANTABILITY OR FITNESS FOR A PARTICULAR PURPOSE, IS MADE IN RELATION TO THE CONTENT OF THIS DOCUMENT. IN NO EVENT WILL NOKIA BE LIABLE FOR ANY DAMAGES, INCLUDING BUT NOT LIMITED TO SPECIAL, DIRECT, INDIRECT, INCIDENTAL OR CONSEQUENTIAL OR ANY LOSSES, SUCH AS BUT NOT LIMITED TO LOSS OF PROFIT, REVENUE, BUSINESS INTERRUPTION, BUSINESS OPPORTUNITY OR DATA THAT MAY ARISE FROM THE USE OF THIS DOCUMENT OR THE INFORMATION IN IT, EVEN IN THE CASE OF ERRORS IN OR OMISSIONS FROM THIS DOCUMENT OR ITS CONTENT.

Copyright and trademark: Nokia is a registered trademark of Nokia Corporation. Other product names mentioned in this document may be trademarks of their respective owners.

© 2021 Nokia.

# Contents

<b>About this document</b> .....	<b>13</b>
<b>1 What's new</b> .....	<b>19</b>
1.1 Overview .....	19
1.2 What's new in BBD Release 21.04 .....	19
<b>2 ETSI ONT safety guidelines</b> .....	<b>21</b>
2.1 Safety instructions .....	21
2.2 Safety standards compliance .....	23
2.3 Electrical safety guidelines .....	23
2.4 ESD safety guidelines .....	24
2.5 Laser safety guidelines .....	24
2.6 Environmental requirements .....	28
<b>3 ETSI environmental and CRoHS guidelines</b> .....	<b>29</b>
3.1 Environmental labels .....	29
3.2 Hazardous Substances Table (HST) .....	31
3.3 Other environmental requirements .....	31
<b>4 ANSI ONT safety guidelines</b> .....	<b>33</b>
4.1 Safety instructions .....	33
4.2 Safety standards compliance .....	35
4.3 Laser safety guidelines .....	37
4.4 Electrical safety guidelines .....	40
4.5 ESD safety guidelines .....	41
4.6 Environmental requirements .....	41
<b>5 XS-2426G-B unit data sheet</b> .....	<b>43</b>
5.1 Overview .....	43
5.2 XS-2426G-B part numbers and identification .....	43
5.3 XS-2426G-B general description .....	45
5.4 XS-2426G-B software and installation feature support .....	51
5.5 XS-2426G-B interfaces and interface capacity .....	51
5.6 XS-2426G-B LEDs .....	53
5.7 XS-2426G-B detailed specifications .....	55
5.8 XS-2426G-B GEM ports and T-CONTs .....	56
5.9 XS-2426G-B performance monitoring statistics .....	56

5.10	XS-2426G-B functional blocks .....	57
5.11	XS-2426G-B standards compliance .....	58
5.12	XS-2426G-B special considerations .....	60
<b>6</b>	<b>Install a XS-2426G-B indoor ONT .....</b>	<b>63</b>
6.1	Overview .....	63
6.2	Purpose .....	63
6.3	General .....	63
6.4	Prerequisites .....	63
6.5	Recommended tools .....	63
6.6	Safety information .....	64
6.7	Procedure.....	64
6.8	Wall mount an XS-2426G-B indoor ONT .....	67
<b>7</b>	<b>Replace a XS-2426G-B indoor ONT .....</b>	<b>73</b>
7.1	Overview .....	73
7.2	Purpose .....	73
7.3	General .....	73
7.4	Prerequisites .....	73
7.5	Recommended tools .....	73
7.6	Safety information .....	74
7.7	Procedure.....	74
<b>8</b>	<b>Configure a XS-2426G-B indoor ONT .....</b>	<b>79</b>
8.1	Overview .....	79
	<b>GUI configuration .....</b>	<b>82</b>
8.2	General configuration .....	82
8.3	HGU mode GUI configuration .....	82
8.4	Log in to web-based GUI .....	82
8.5	Viewing overview information.....	83
	<b>Viewing device information and connection status .....</b>	<b>85</b>
8.6	Overview .....	85
8.7	Viewing device information.....	85
8.8	Viewing LAN status .....	87
8.9	Viewing WAN status.....	88
8.10	Viewing WAN IPv6 status.....	89
8.11	Viewing STA information .....	90
8.12	Viewing Neighboring Access Points .....	91
8.13	Viewing home networking information.....	92

---

8.14	Viewing optics module status .....	93
8.15	Viewing statistics .....	94
8.16	Viewing voice information.....	96
	<b>Network configuration</b> .....	<b>98</b>
8.17	Overview .....	98
8.18	Configuring LAN.....	98
8.19	Configuring LAN IPv6.....	100
8.20	Configuring WAN.....	101
8.21	Configuring WAN DHCP .....	103
8.22	Configuring Wireless 2.4GHz.....	104
8.23	Configuring Wireless 5GHz.....	106
8.24	Configuring wireless scheduling.....	108
8.25	Configuring IP routing .....	109
8.26	Configuring DNS .....	110
8.27	Configuring TR-069 .....	111
8.28	Configuring GRE tunnel .....	112
8.29	Configuring Upstream (US) Classifier .....	113
8.30	Configuring QoS.....	117
	<b>Security configuration</b> .....	<b>120</b>
8.31	Overview .....	120
8.32	Configuring the firewall.....	120
8.33	Configuring the MAC filter .....	121
8.34	Configuring the IP filter.....	122
8.35	Configuring the URL filter .....	123
8.36	Configuring DMZ and ALG .....	124
8.37	Configuring access control.....	125
	<b>Configuring the Application</b> .....	<b>127</b>
8.38	Overview .....	127
8.39	Configuring port forwarding.....	127
8.40	Configuring port triggering.....	128
8.41	Configuring DDNS.....	129
8.42	Configuring NTP.....	130
8.43	Configuring USB .....	131
8.44	Configuring UPnP and DLNA.....	132
	<b>Maintenance</b> .....	<b>133</b>
8.45	Overview .....	133
8.46	Configuring the password .....	133

---

8.47	Configuring LOID .....	134
8.48	Configuring SLID .....	135
8.49	Managing the device .....	136
8.50	Backing up the configuration .....	137
8.51	Restoring the configuration .....	138
8.52	Upgrading firmware .....	139
8.53	Rebooting the device .....	139
8.54	Resetting to factory defaults.....	140
8.55	Diagnosing WAN connections.....	141
8.56	Viewing log files .....	142
	<b>RG Troubleshooting Counters .....</b>	<b>144</b>
8.57	Overview .....	144
8.58	Viewing Residential Gateway (RG) troubleshooting counters.....	144
<b>9</b>	<b>ONT configuration file over OMCI .....</b>	<b>147</b>
9.1	Overview .....	147
9.2	Purpose .....	147
9.3	Supported configuration file types.....	147
9.4	ONT configuration file over OMCI .....	149

## List of tables

Table 2-1	Safety labels.....	22
Table 4-1	Safety labels.....	34
Table 5-1	Identification of XS-2426G-B indoor ONTs.....	43
Table 5-2	XS-2426G-B power supply ordering information.....	44
Table 5-3	Hardware parts required for XS-2426G-B installations.....	45
Table 5-4	XS-2426G-B indoor ONT interface connection capacity.....	51
Table 5-5	XS-2426G-B indoor ONT physical connections.....	52
Table 5-6	XS-2426G-B indoor ONT LED descriptions.....	54
Table 5-7	XS-2426G-B indoor ONT physical specifications.....	55
Table 5-8	XS-2426G-B dimension data specifications.....	55
Table 5-9	XS-2426G-B indoor ONT power consumption specifications.....	56
Table 5-10	XS-2426G-B indoor ONT environmental specifications.....	56
Table 5-11	XS-2426G-B indoor ONT capacity for GEM ports and T-CONTs.....	56
Table 5-12	XS-2426G-B ONT generic performance monitoring statistics.....	57
Table 5-13	XS-2426G-B ONT ONTL2UNI performance monitoring statistics.....	57
Table 5-14	Responsible party contact information.....	59
Table 5-15	XS-2426G-B ONT considerations and limitations.....	61
Table 8-1	Overview parameters.....	84
Table 8-2	Device Information parameters.....	86
Table 8-3	LAN Status parameters.....	87
Table 8-4	WAN Status parameters.....	88
Table 8-5	WAN Status IPv6 parameters.....	89
Table 8-6	STA information parameters.....	91
Table 8-7	Neighboring AP parameters.....	92
Table 8-8	Home Networking parameters.....	93
Table 8-9	Optics Module Status parameters.....	94
Table 8-10	Voice Information parameters.....	96
Table 8-11	LAN parameters.....	99
Table 8-12	LAN IPv6 parameters.....	100
Table 8-13	WAN parameters.....	102
Table 8-14	WAN DHCP parameters.....	103

---

Table 8-15	Wireless (2.4GHz) parameters.....	105
Table 8-16	Wireless (5GHz) parameters.....	107
Table 8-17	IP Routing parameters .....	110
Table 8-18	DNS parameters.....	111
Table 8-19	TR-069 parameters .....	112
Table 8-20	GRE Tunnel parameters.....	113
Table 8-21	US Classifier Policy parameters.....	114
Table 8-22	US Classifier parameters .....	115
Table 8-23	US Classifier Rules parameters .....	116
Table 8-24	QoS Config parameters.....	119
Table 8-25	Firewall parameters.....	121
Table 8-26	MAC Filter parameters .....	121
Table 8-27	IP Filter parameters.....	123
Table 8-28	URL Filter parameters.....	124
Table 8-29	ALG parameters.....	124
Table 8-30	DMZ parameters .....	125
Table 8-31	Access Control parameters.....	126
Table 8-32	Trusted Network parameters.....	126
Table 8-33	Port Forwarding parameters .....	128
Table 8-34	Port Triggering parameters .....	129
Table 8-35	DDNS parameters.....	130
Table 8-36	NTP parameters.....	131
Table 8-37	USB parameters.....	132
Table 8-38	Password parameters .....	134
Table 8-39	LOID Configuration parameters .....	135
Table 8-40	SLID Configuration parameters.....	136
Table 8-41	Device Management parameters.....	137
Table 8-42	RG Troubleshooting Counters parameters .....	145
Table 9-1	Supported configuration files.....	148
Table 9-2	Download configuration files .....	149



## List of figures

Figure 2-1	PSE certification .....	22
Figure 2-2	Laser product label .....	25
Figure 2-3	Laser classification label.....	26
Figure 2-4	Laser warning labels.....	27
Figure 3-1	Products below MCV value label.....	30
Figure 3-2	Products above MCV value label .....	30
Figure 3-3	Recycling/take back/disposal of product symbol .....	32
Figure 4-1	Sample safety label on the ONT equipment.....	35
Figure 4-2	Sample laser product label showing CDRH 21 CFR compliance.....	37
Figure 4-3	Laser product label .....	38
Figure 4-4	Laser classification label.....	38
Figure 4-5	Laser warning labels.....	39
Figure 4-6	Sample laser product safety label on the ONT equipment .....	40
Figure 5-1	XS-2426G-B ONT.....	46
Figure 5-2	XS-2426G-B indoor ONT physical connections (back).....	52
Figure 5-3	XS-2426G-B indoor ONT LEDs .....	53
Figure 5-4	XS-2426G-B ONT functional block.....	58
Figure 6-1	XS-2426G-B ONT connections.....	65
Figure 6-2	XS-2426G-B ONT in wall mounting bracket .....	68
Figure 6-3	XS-2426G-B wall mount bracket .....	69
Figure 6-4	ONT to wall mount connection.....	70
Figure 6-5	ONT in wall mount bracket—facing the room.....	71
Figure 6-6	ONT in wall mount bracket—facing the room / wall.....	72
Figure 7-1	XS-2426G-B indoor ONT connections.....	75
Figure 7-2	XS-2426G-B indoor ONT connections (labelled).....	76
Figure 8-1	Web login page.....	83
Figure 8-2	Device Information page.....	86
Figure 8-3	LAN Status page .....	87
Figure 8-4	WAN Status page .....	88
Figure 8-5	WAN Status IPv6 page .....	89
Figure 8-6	STA Information page .....	91

Figure 8-7	Neighboring AP page .....	92
Figure 8-8	Home Networking page .....	93
Figure 8-9	Optics Module Status page .....	94
Figure 8-10	LAN Statistics page .....	95
Figure 8-11	WAN Statistics page .....	95
Figure 8-12	WLAN Statistics page .....	95
Figure 8-13	Voice Information page .....	96
Figure 8-14	LAN page .....	99
Figure 8-15	LAN IPv6 page .....	100
Figure 8-16	WAN page .....	101
Figure 8-17	WAN DHCP page .....	103
Figure 8-18	Wireless (2.4GHz) page .....	104
Figure 8-19	Wireless (5GHz) page .....	106
Figure 8-20	Wireless Schedule page .....	108
Figure 8-21	IP Routing page .....	109
Figure 8-22	DNS page .....	110
Figure 8-23	TR-069 page .....	111
Figure 8-24	GRE Tunnel page .....	112
Figure 8-25	US Classifier Policy page .....	114
Figure 8-26	US Classifier page .....	115
Figure 8-27	US Classifier Rules page .....	116
Figure 8-28	QoS Config page (L3 packet sizes) .....	118
Figure 8-29	QoS Config page (L3 packet sizes) continued .....	118
Figure 8-30	Firewall page .....	120
Figure 8-31	MAC Filter page .....	121
Figure 8-32	IP Filter page .....	122
Figure 8-33	URL Filter page .....	123
Figure 8-34	DMZ and ALG page .....	124
Figure 8-35	Access Control page .....	125
Figure 8-36	Port Forwarding page .....	127
Figure 8-37	Port Triggering page .....	128
Figure 8-38	DDNS page .....	129
Figure 8-39	NTP page .....	130

---

Figure 8-40	USB page .....	131
Figure 8-41	UPnP and DLNA page .....	132
Figure 8-42	Password page .....	134
Figure 8-43	LOID Config page .....	135
Figure 8-44	SLID Configuration page .....	136
Figure 8-45	Device Management page .....	137
Figure 8-46	Backup and Restore page .....	138
Figure 8-47	Backup and Restore page .....	138
Figure 8-48	Firmware Upgrade page .....	139
Figure 8-49	Reboot Device page .....	140
Figure 8-50	Factory Default page .....	140
Figure 8-51	Diagnostics page .....	141
Figure 8-52	Log page .....	142
Figure 8-53	RG Troubleshooting Counters page .....	144



---

# About this document

## Purpose

This documentation set provides information about safety, features and functionality, ordering, hardware installation and maintenance, and software installation procedures of this ONT for the current release.

## Intended audience

This documentation set is intended for planners, administrators, operators, and maintenance personnel involved in installing, upgrading, or maintaining the ONTs.

The reader must be familiar with general telecommunications principles.

## Safety information

For your safety, this document contains safety statements. Safety statements are given at points where risks of damage to personnel, equipment, and operation may exist. Failure to follow the directions in a safety statement may result in serious consequences.

## Safety Information Examples



### DANGER

#### Hazard

*Danger indicates that the described activity or situation may result in serious personal injury or death; for example, high voltage or electric shock hazards.*



### WARNING

#### Equipment Damage

*Warning indicates that the described activity or situation may, or will, cause equipment damage or serious performance problems.*



### CAUTION

#### Service Disruption

*Caution indicates that the described activity or situation may, or will, cause service interruption.*

**Note:** A note provides information that is, or may be, of special interest.

## Acronyms and initialisms

The expansions and optional descriptions of most acronyms and initialisms appear in the glossary

---

## Nokia quality processes

Nokia's ONT manufacturing, testing, and inspecting practices are in compliance with TL 9000 requirements. These requirements are documented in the Fixed Networks Quality Manual 3FQ-30146-6000-QRZZA.

The quality practices adequately ensure that technical requirements and customer end-point requirements are met. The customer or its representatives may be allowed to perform on-site quality surveillance audits, as agreed upon during contract negotiations.

## Documents

Documents are available using ALED or OLCS.

## To download a ZIP file package of the customer documentation

- 1 \_\_\_\_\_  
Navigate to <http://customer.nokia.com/s/> and enter your user name and password. If you are a new user and require access to this service, please contact your Nokia sales representative.
- 2 \_\_\_\_\_  
Select **Products**.
- 3 \_\_\_\_\_  
Type your product name in the **Find and select a product** field and click the search icon.  
Select a product.
- 4 \_\_\_\_\_  
Click **Downloads: ALED** to go to the Electronic Delivery: Downloads page.
- 5 \_\_\_\_\_  
Select **Documentation** from the list.
- 6 \_\_\_\_\_  
Select a release from the list.
- 7 \_\_\_\_\_  
Follow the on-screen directions to download the file.

END OF STEPS \_\_\_\_\_

## To access individual documents

Individual PDFs of customer documents are also accessible through the Nokia Support Portal website.

- 
- 1 \_\_\_\_\_  
Navigate to <http://customer.nokia.com/s/> and enter your user name and password. If you are a new user and require access to this service, please contact your Nokia sales representative.
  - 2 \_\_\_\_\_  
Select **Products**.
  - 3 \_\_\_\_\_  
Type your product name in the **Find and select a product** field and click the search icon.  
Select a product.
  - 4 \_\_\_\_\_  
Click **Documentation: Doc Center** to go to the product page in the Doc Center.
  - 5 \_\_\_\_\_  
Select a release from the **Release** list and click **SEARCH**.
  - 6 \_\_\_\_\_  
Click on the PDF icon to open or save the file.

END OF STEPS \_\_\_\_\_

## Procedures with options or substeps

When there are options in a procedure, they are identified by letters. When there are required substeps in a procedure, they are identified by roman numerals.

### Example of options in a procedure

At [Step 1](#), you can choose option a or b. At [Step 2](#), you must do what the step indicates.

- 1 \_\_\_\_\_  
This step offers two options. You must choose one of the following:
  - a. This is one option.
  - b. This is another option.
- 2 \_\_\_\_\_  
You must perform this step.

END OF STEPS \_\_\_\_\_

### Example of required substeps in a procedure

At [Step 1](#), you must perform a series of substeps within a step. At [Step 2](#), you must do what the step indicates.

---

**1**

This step has a series of substeps that you must perform to complete the step. You must perform the following substeps:

- a. This is the first substep.
- b. This is the second substep.
- c. This is the third substep.

**2**

You must perform this step.

**END OF STEPS**

---

## Multiple PDF document search

You can use Adobe Reader Release 6.0 and later to search multiple PDF files for a common term. Adobe Reader displays the results in a single display panel. The results are grouped by PDF file, and you can expand the entry for each file.

**Note:**The PDF files in which you search must be in the same folder.

### To search multiple PDF files for a common term

**1**

Open Adobe Acrobat Reader.

**2**

Choose **Edit**→**Search** from the Acrobat Reader main menu. The Search PDF panel displays.

**3**

Enter the search criteria.

**4**

Select **All PDF Documents In**.

**5**

Select the folder in which to search using the drop-down menu.

**6**

Click **Search**.

Acrobat Reader displays the search results. You can expand the entries for each document by clicking on the + symbol.

**END OF STEPS**

---



---

## Technical support

For details, refer to the [Nokia Support portal \(https://customer.nokia.com/support/s/\)](https://customer.nokia.com/support/s/).

For ordering information, contact your Nokia sales representative.

## How to comment

Note to reviewers: The following "How to comment" text will appear in the final document when it is published. However, the feedback method described below is for use only on final documents. Please send your review comments to the author using the process you were given when you received this draft document.

To comment on this document, go to the [Online Comment Form \(https://documentation.nokia.com/comments/\)](https://documentation.nokia.com/comments/) or e-mail your comments to the [Comments Hotline \(mailto:comments@nokia.com\)](mailto:comments@nokia.com).



---

# 1 What's new

## 1.1 Overview

### 1.1.1 Purpose

This chapter provides tables of the feature and document changes applicable to this guide.

### 1.1.2 Contents

<a href="#">1.1 Overview</a>	19
<a href="#">1.2 What's new in BBD Release 21.04</a>	19

## 1.2 What's new in BBD Release 21.04

The Product guide is a new guide in BBD Release 21.04, issue 1. In future releases, this chapter will provide tables of the feature and document changes applicable to this guide.



## 2 ETSI ONT safety guidelines

This chapter provides information about the mandatory regulations that govern the installation and operation of the optical network terminals (ONTs).

### 2.1 Safety instructions

This section describes the safety instructions that are provided in the ONT customer documentation and on the equipment.

#### 2.1.1 Safety instruction boxes

The safety instruction boxes are provided in the ONT customer documentation. Observe the instructions to meet safety requirements.

The following is an example of the Danger box.



#### **DANGER**

##### **Hazard**

*Possibility of personal injury.*

The Danger box indicates that the described activity or situation may pose a threat to personal safety. It calls attention to a situation or procedure which, if not correctly performed or adhered to, may result in death or serious physical harm.

Do not proceed beyond a Danger box until the indicated conditions are fully understood and met.

The following is an example of the Warning box.



#### **WARNING**

##### **Equipment Damage**

*Possibility of equipment damage.*

*Possibility of data loss.*

The Warning box indicates that the described activity or situation may, or will, cause equipment damage, loss of data, or serious performance problems. It identifies a possible equipment-damaging situation or provides essential information to avoid the degradation of system operations or data.

Do not proceed beyond a warning until the indicated conditions are fully understood and met.

The following is an example of the Caution box.

**CAUTION****Service Disruption**

*Possibility of service interruption.*

*Service interruption.*

The Caution box indicates that the described activity or situation may, or will, cause service interruption.

Do not proceed beyond a caution until the indicated conditions are fully understood and met.

The following is an example of the Note box.



**Note:** Information of special interest.

The Note box provides information that assists the personnel working with ONTs. It does not provide safety-related instructions.

## 2.1.2 Safety-related labels

The ONT equipment is labeled with the specific safety instructions and compliance information that is related to a variant of the ONT. Observe the instructions on the safety labels.



The following table provides sample safety labels on the ONT equipment.

Table 2-1 Safety labels

Description	Label text
ESD warning	Caution: This assembly contains an electrostatic sensitive device.
Laser classification	Class 1 laser product
PSE marking	These power supplies are Japan PSE certified and compliant with Japan VCCI emissions standards.

Figure 2-1, "PSE certification" (p. 22) shows the PSE certification.

Figure 2-1 PSE certification

 Warning	This is a Class B product based on the standard of the Voluntary Control Council for Interference from Information Technology Equipment (VCCI). If this is used near a radio or television receiver in a domestic environment, it may cause radio interference. Install and use the equipment according to the instruction manual.
 警告	VCCI準拠クラスB機器（日本） この機器は、Information Technology EquipmentのVoluntary Control Council for Interference (VCCI)の規格に準拠したクラスB製品です。この機器をラジオやテレビ受信機の近くで使用した場合、混信が発生する恐れがあります。本機器の設置および使用に際しては、取扱説明書に従ってください。

19841

## 2.2 Safety standards compliance

This section describes the ONT compliance with the European safety standards.

### 2.2.1 EMC, EMI, and ESD compliance

The ONT equipment complies with the following EMC, EMI, and ESD requirements:

- EN 300-328 v1.9.1 wide band data transmission standards for 2.4GHz bands
- EN 300-386 V1.5.1: Electromagnetic Compatibility and Radio Spectrum Matters (ERM): Telecommunications Network Equipment; Electromagnetic Compatibility (EMC) requirements; Electrostatic Discharge (ESD) requirements
- EN 55022 (2006): Class B, Information Technology Equipment, Radio Disturbance Characteristics, limits and methods of measurement
- EN 55024 (2010): Information Technology Equipment, Immunity Characteristics, limits and methods of measurement
- European Council Directive 2004/108/EC
- EN 300-386 V1.4.1: 2008
- EN 55022:2006 Class B (ONTs)

### 2.2.2 Equipment safety standard compliance

The ONT equipment complies with the requirements of EN 62368-1, Safety of Information Technology Equipment for use in a restricted location (per R-269).

### 2.2.3 Environmental standard compliance

The ONT equipment complies with the EN 300 019 European environmental standards.

### 2.2.4 Laser product standard compliance

For most ONTs, the ONT equipment complies with EN 60825-1 and IEC 60825-2 for laser products. If there is an exception to this compliance regulation, you can find this information in the standards compliance section of the unit data sheet in this Product Guide.

### 2.2.5 Resistibility requirements compliance

The ONT equipment complies with the requirements of ITU Recommendation K.21 for resistibility of telecommunication equipment installed in customer premises to over voltage and over currents.

### 2.2.6 Acoustic noise emission standard compliance

The ONT equipment complies with EN 300 753 acoustic noise emission limit and test methods.

## 2.3 Electrical safety guidelines

This section provides the electrical safety guidelines for the ONT equipment.

**i** **Note:** The ONTs comply with the U.S. National Electrical Code. However, local electrical authorities have jurisdiction when there are differences between the local and U.S. standards.

---

The ONTs comply with BS EN 61140.

### 2.3.1 Power supplies

The use of any non-Nokia approved power supplies or power adapters is not supported or endorsed by Nokia. Such use will void any warranty or support contract with Nokia. Such use greatly increases the danger of damage to equipment or property.

### 2.3.2 Cabling

The following are the guidelines regarding cables used for the ONT equipment:

- All cables must be approved by the relevant national electrical code.
- The cables for outdoor installation of ONTs must be suitable for outdoor use.
- POTS wiring run outside the subscriber premises must comply with the requirements of local electrical codes. In some markets, the maximum allowed length of the outside run is 140 feet (43 m). If the outside run is longer, NEC requires primary protection at both the exit and entry points for the wire.

### 2.3.3 Protective earth

Earthing and bonding of the ONTs must comply with the requirements of local electrical codes.

## 2.4 ESD safety guidelines

The ONT equipment is sensitive to ESD. Operations personnel must observe the following ESD instructions when they handle the ONT equipment.



### CAUTION

#### Service Disruption

*This equipment is ESD sensitive. Proper ESD protections should be used when you enter the TELCO Access portion of the ONT.*

During installation and maintenance, service personnel must wear wrist straps to prevent damage caused by ESD.

## 2.5 Laser safety guidelines

Observe the following instructions when you perform installation, operations, and maintenance tasks on the ONT equipment.

Only qualified service personnel who are extremely familiar with laser radiation hazards should install or remove the fiber optic cables and units in this system.





**DANGER**

**Hazard**

*There may be invisible laser radiation at the fiber optic cable when the cable is removed from the connector. Avoid direct exposure to the laser beam.*

Observe the following danger for laser hazard. Eyes can be damaged when they are exposed to a laser beam. Take necessary precautions before you plug in the optical modules.



**DANGER**

**Hazard**

*Possibility of equipment damage. Risk of eye damage by laser radiation.*

### 2.5.1 Laser classification

The ONT is classified as a Class 1 laser product based on its transmit optical output.

#### Laser warning labels

The following figures show the labels related to laser product, classification and warning.

The following figure shows a laser product label.

Figure 2-2 Laser product label

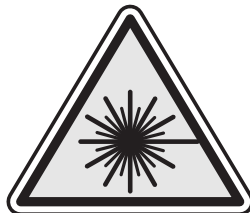

18455

Figure 2-3, “Laser classification label” (p. 26) shows a laser classification label. Laser classification labels may be provided in other languages.

Figure 2-3 Laser classification label

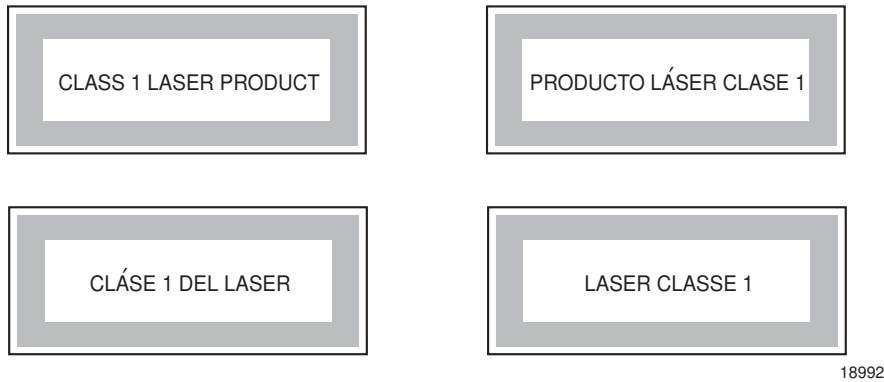
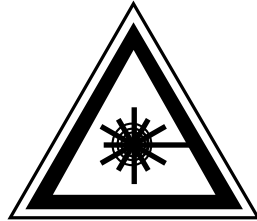

Figure 2-4, “Laser warning labels” (p. 27) shows a laser warning label and an explanatory label for laser products. Labels and warning may be provided in other languages. The explanatory label provides the following information:

- A warning that calls attention to the invisible laser radiation
- An instruction against staring into the beam or viewing directly with optical instruments
- Wavelength
- Normal output power
- Maximum output power

Figure 2-4 Laser warning labels



Laser Warning Label

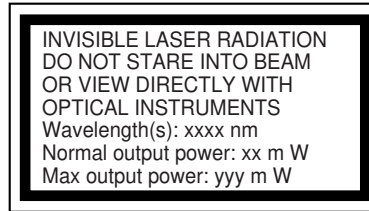

Laser Warning Label

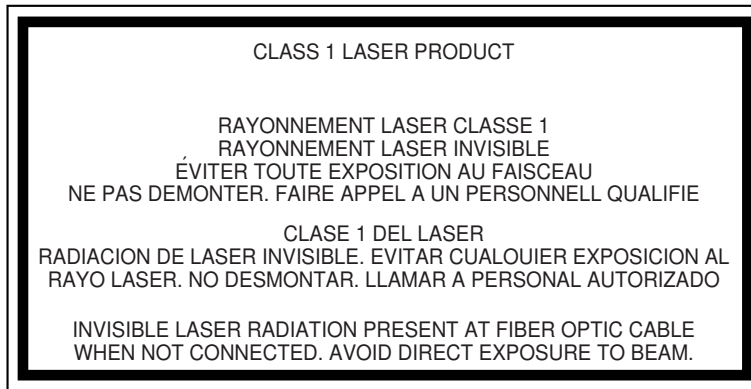

Laser Warning Label

18993

## 2.5.2 Transmit optical output

The maximum transmit optical output of an ONT is +9 dBm.

## 2.5.3 Normal laser operation

In normal operation, fiber cable laser radiation is always off until it receives signal from the line terminal card.

Eyes can be damaged when they are exposed to a laser beam. Operating personnel must observe the instructions on the laser explanatory label before plugging in the optical module.



**DANGER**

**Hazard**

*Risk of eye damage by laser radiation.*

## 2.5.4 Location class

Use cable supports and guides to protect the receptacles from strain.

---

## 2.6 Environmental requirements

See the ONT technical specification documentation for more information about temperature ranges.

During operation in the supported temperature range, condensation inside the ONT caused by humidity is not an issue. To avoid condensation caused by rapid changes in temperature and humidity, Nokia recommends:

- The door of the ONT not be opened until temperature inside and outside the enclosure has stabilized.
- If the door of the ONT must be opened after a rapid change in temperature or humidity, use a dry cloth to wipe down the metal interior to prevent the risk of condensation.
- When high humidity is present, installation of a cover or tent over the ONT helps prevent condensation when the door is opened.

## 3 ETSI environmental and CRoHS guidelines

This chapter provides information about the ETSI environmental China Restriction of Hazardous Substances (CRoHS) regulations that govern the installation and operation of the optical line termination (OLT) and optical network termination (ONT) systems. This chapter also includes environmental operation parameters of general interest.

### 3.1 Environmental labels

This section describes the environmental instructions that are provided with the customer documentation, equipment, and location where the equipment resides.

#### 3.1.1 Overview

CRoHS is applicable to Electronic Information Products (EIP) manufactured or sold and imported in the territory of the mainland of the People's Republic of China. EIP refers to products and their accessories manufactured by using electronic information technology, including electronic communications products and such subcomponents as batteries and cables.

#### 3.1.2 Environmental related labels

Environmental labels are located on appropriate equipment. The following are sample labels.

##### Products below Maximum Concentration Value (MCV) label

Figure 3-1, "Products below MCV value label" (p. 30) shows the label that indicates a product is below the maximum concentration value, as defined by standard SJ/T11363-2006 (Requirements for Concentration Limits for Certain Hazardous Substances in Electronic Information Products). Products with this label are recyclable. The label may be found in this documentation or on the product.

*Figure 3-1* Products below MCV value label

18986

### Products containing hazardous substances above Maximum Concentration Value (MCV) label

Figure 3-2, “Products above MCV value label” (p. 30) shows the label that indicates a product is above the maximum concentration value, as defined by standard SJ/T11363-2006 (Requirements for Concentration Limits for Certain Hazardous Substances in Electronic Information Products). The number contained inside the label indicates the Environment-Friendly User Period (EFUP) value. The label may be found in this documentation or on the product.

*Figure 3-2* Products above MCV value label

Together with major international telecommunications equipment companies, Nokia has determined it is appropriate to use an EFUP of 50 years for network infrastructure equipment and an EFUP of 20 years for handsets and accessories. These values are based on manufacturers' extensive practical experience of the design, manufacturing, maintenance, usage conditions, operating

environments, and physical condition of infrastructure and handsets after years of service. The values reflect minimum values and refer to products operated according to the intended use conditions. See 3.2 “Hazardous Substances Table (HST)” (p. 30) for more information.

## 3.2 Hazardous Substances Table (HST)

This section describes the compliance of the OLT and ONT equipment to the CRoHS standard when the product and sub assemblies contain hazardous substances beyond the MCV value. This information is found in this user documentation where part numbers for the product and sub assemblies are listed. It may be referenced in other OLT and ONT documentation.

In accordance with the People’s Republic of China Electronic Industry Standard Marking for the Control of Pollution Caused by Electronic Information Products (SJ/T11364-2006), customers may access the Nokia Hazardous Substance Table, in Chinese, from the following location:

- <http://www.nokia-sbell.com.cn/wwwroot/images/upload/private/1/media/ChinaRoHS.pdf>  
(<http://www.nokia-sbell.com.cn/wwwroot/images/upload/private/1/media/ChinaRoHS.pdf>)

## 3.3 Other environmental requirements

Observe the following environmental requirements when handling the P-OLT or ONT equipment.

### 3.3.1 ONT environmental requirements

See the ONT technical specification documentation for more information about temperature ranges.

### 3.3.2 Storage

According to ETS 300-019-1-1 - Class 1.1, storage of ONT equipment must be in Class 1.1, weather-protected, temperature-controlled locations.

### 3.3.3 Transportation

According to EN 300-019-1-2 - Class 2.3, transportation of the ONT equipment must be in packed, public transportation with no rain on packing allowed.

### 3.3.4 Stationary use

According to EN 300-019-1-3 - Class 3.1/3.2/3.E, stationary use of ONT equipment must be in a temperature-controlled location, with no rain allowed, and with no condensation allowed.

### 3.3.5 Material content compliance

European Union (EU) Directive 2002/95/EC, “Restriction of the use of certain Hazardous Substances” (RoHS), restricts the use of lead, mercury, cadmium, hexavalent chromium, and certain flame retardants in electrical and electronic equipment. This Directive applies to electrical and electronic products placed on the EU market after 1 July 2006, with various exemptions, including an exemption for lead solder in network infrastructure equipment. Nokia products shipped to the EU after 1 July 2006 comply with the EU RoHS Directive.

Nokia has implemented a material/substance content management process. The process is described in: Nokia process for ensuring RoHS Compliance (1AA002660031ASZZA). This ensures

compliance with the European Union Directive 2011/65/EU on the Restriction of the Use of Certain Hazardous Substances in Electrical and Electronic Equipment (RoHS2). With the process equipment is assessed in accordance with the Harmonised Standard EN50581:2012 (CENELEC) on Technical documentation for the assessment of electrical and electronic products with respect to the restriction of hazardous substances.

### 3.3.6 End-of-life collection and treatment

Electronic products bearing or referencing the symbol shown in [Figure 3-3, “Recycling/take back/disposal of product symbol”](#) (p. 31), when put on the market within the European Union (EU), shall be collected and treated at the end of their useful life, in compliance with applicable EU and local legislation. They shall not be disposed of as part of unsorted municipal waste. Due to materials that may be contained in the product, such as heavy metals or batteries, the environment and human health may be negatively impacted as a result of inappropriate disposal.

**i** **Note:** In the European Union, a solid bar under the symbol for a crossed-out wheeled bin indicates that the product was put on the market after 13 August 2005.

Figure 3-3 Recycling/take back/disposal of product symbol



At the end of their life, the OLT and ONT products are subject to the applicable local legislations that implement the European Directive 2012/19EU on waste electrical and electronic equipment (WEEE).

There can be different requirements for collection and treatment in different member states of the European Union.

In compliance with legal requirements and contractual agreements, where applicable, Nokia will offer to provide for the collection and treatment of Nokia products bearing the logo shown in [Figure 3-3, “Recycling/take back/disposal of product symbol”](#) (p. 32) at the end of their useful life, or products displaced by Nokia equipment offers. For information regarding take-back of equipment by Nokia, or for more information regarding the requirements for recycling/disposal of product, contact your Nokia account manager or Nokia take back support at [sustainability.global@nokia.com](mailto:sustainability.global@nokia.com).



## 4 ANSI ONT safety guidelines

This chapter provides information about the mandatory regulations that govern the installation and operation of the optical network terminals or units (ONTs or ONUs) in the North American or ANSI market.

### 4.1 Safety instructions

This section describes the safety instructions that are provided in the ONT customer documentation and on the equipment.

#### 4.1.1 Safety instruction boxes in customer documentation

The safety instruction boxes are provided in the ONT customer documentation. Observe the instructions to meet safety requirements.

The following is an example of the Danger box.



#### **DANGER**

#### **Hazard**

*Possibility of personal injury.*

The Danger box indicates that the described activity or situation may pose a threat to personal safety. It calls attention to a situation or procedure which, if not correctly performed or adhered to, may result in death or serious physical harm.

Do not proceed beyond a Danger box until the indicated conditions are fully understood and met.

The following is an example of the Warning box.



#### **WARNING**

#### **Equipment Damage**

*Possibility of equipment damage.*

*Possibility of data loss.*

The Warning box indicates that the described activity or situation may, or will, cause equipment damage, loss of data, or serious performance problems. It identifies a possible equipment-damaging situation or provides essential information to avoid the degradation of system operations or data.

Do not proceed beyond a warning until the indicated conditions are fully understood and met.

The following is an example of the Caution box.

**CAUTION****Service Disruption**

*Possibility of service interruption.*

*Service interruption.*

The Caution box indicates that the described activity or situation may, or will, cause service interruption.

Do not proceed beyond a caution until the indicated conditions are fully understood and met.

The following is an example of the Note box.



**Note:** Information of special interest.

The Note box provides information that assists the personnel working with ONTs. It does not provide safety-related instructions.

### 4.1.2 Safety-related labels

The ONT equipment is labeled with specific safety compliance information and instructions that are related to a variant of the ONT. Observe the instructions on the safety labels.

[Table 4-1, "Safety labels" \(p. 33\)](#) provides examples of the text in the various ONT safety labels.

Table 4-1 Safety labels

Description	Label text
UL compliance	Communication service equipment US listed. Type 3R enclosure - Rainproof.
TUV compliance	Type 3R enclosure - Rainproof.
ESD warning	Caution: This assembly contains electrostatic sensitive device.
Laser classification	Class 1 laser product
Laser product compliance	This laser product conforms to all applicable standards of 21 CFR 1040.10 at date of manufacture.
FCC standards compliance	Tested to comply with FCC standards for home or office use.
CDRH compliance	Complies with 21 CFR 1040.10 and 1040.11 except for deviations pursuant to Laser Notice No. 50, dated June 24, 2007
Operation conditions	This device complies with Part 15 of the FCC Rules. Operation is subject to the following two conditions: (1) this device may not cause harmful interference, and (2) this device must accept any interference received, including interference that may cause undesired operation.
Canadian standard compliance (modular ONT)	This Class A digital apparatus complies with Canadian ICES-003.
Canadian standard compliance (outdoor ONT)	This Class B digital apparatus complies with Canadian ICES-003.
CE marking	There are various CE symbols for CE compliance.

The following table shows a sample safety label on the ONT equipment.

Figure 4-1 Sample safety label on the ONT equipment

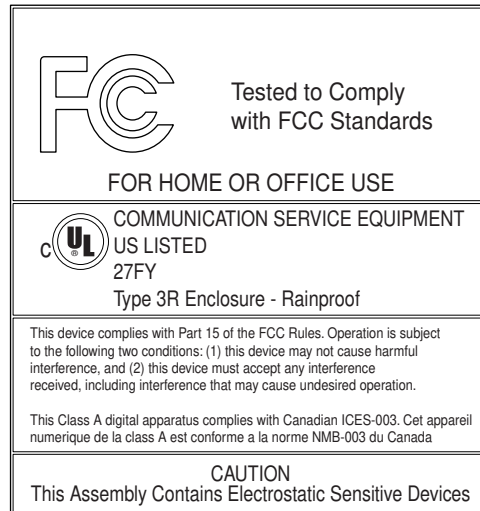

18533

## 4.2 Safety standards compliance

This section describes the ONT compliance with North American safety standards.



### WARNING

#### Equipment Damage

*Changes or modifications to this unit not expressly approved by the party responsible for compliance could void the user's authority to operate the equipment.*

### 4.2.1 EMC, EMI, and ESD standards compliance

The ONT equipment complies with the following requirements:

- Federal Communications Commission (FCC) CFR 47, Part 15, Subpart B, Class A requirements for OLT equipment
- GR-1089-CORE requirements, including:
  - Section 3 Electromagnetic Interference, Emissions Radiated and Conducted
  - Section 3 Immunity, Radiated and Conducted
  - Section 2 ESD Discharge Immunity: System Level Electrostatic Discharge and EFT Immunity: Electrically Fast Transients

This equipment has been tested and found to comply with the limits for a Class B digital device, pursuant to Part 15 of the FCC Rules. These limits are designed to provide reasonable protection against harmful interference in a residential installation. This equipment generates, uses and can

radiate radio frequency energy and, if not installed and used in accordance with the instructions, may cause harmful interference to radio communications.

However, there is no guarantee that interference will not occur in a particular installation. If this equipment does cause harmful interference to radio or television reception, which can be determined by turning the equipment off and on, the user is encouraged to try to correct the interference by one or more of the following measures:

- Reorient or relocate the receiving antenna.
- Increase the separation between the equipment and receiver.
- Connect the equipment into an outlet on a circuit different from that to which the receiver is needed.
- Consult the dealer or an experienced radio/TV technician for help.

#### 4.2.2 Equipment safety standard compliance

The ONT equipment complies with the requirements of UL60950-1, Outdoor ONTs to “Communication Service Equipment” (CSE) and Indoor ONTs to Information Technology Equipment (ITE).

#### 4.2.3 Environmental standards compliance

The ONT equipment complies with the following standards:

- GR-63-CORE (NEBS): requirements related to operating, storage, humidity, altitude, earthquake, office vibration, transportation and handling, fire resistance and spread, airborne contaminants, illumination, and acoustic noise
- GR-487-CORE: requirements related to rain, chemical, sand, and dust
- GR-487 R3-82: requirements related to condensation
- GR-3108: Requirements for Network Equipment in the Outside Plant (OSP)
- TP76200: Common Systems Equipment Interconnections Standards

#### 4.2.4 Laser product standards compliance

The ONT equipment complies with 21 CFR 1040.10 and CFR 1040.11, except for deviations pursuant to Laser Notice No. 50, dated June 24, 2007” or to 21 CFR 1040.10 U.S. Center for Devices and Radiological Health (CDRH) of the Food and Drug Administration (FDA) Laser Notice 42 for ONTs containing Class 1 Laser modules certified by original manufactures.

Per CDRH 21 CFR 10.40.10 (h) (1) (iv) distributors of Class 1 laser products, such as Nokia ONTs shall leave the following Laser Safety cautions with the end user.

a) “Class 1 Laser Product”

b) “Caution – Use of controls or adjustments or performance of procedures other than those specified herein may result in hazardous radiation exposure.”

[Figure 4-2, “Sample laser product label showing CDRH 21 CFR compliance” \(p. 37\)](#) shows a laser product label.

Figure 4-2 Sample laser product label showing CDRH 21 CFR compliance



#### 4.2.5 Resistibility requirements compliance

The ONT equipment complies with the requirements of ITU Recommendation K.21 for resistibility of telecommunication equipment installed in customer premises to over voltage and over currents.

### 4.3 Laser safety guidelines

Only qualified service personnel who are extremely familiar with laser radiation hazards should install or remove the fiber optic cables and units in this system.

Observe the following warnings when you perform installation, operations, and maintenance tasks on the ONT equipment.



*There may be invisible laser radiation at the fiber optic cable when the cable is removed from the connector. Avoid direct exposure to beam.*

Observe the following danger for a laser hazard. Eyes can be damaged when they are exposed to a laser beam. Take necessary precautions before you plug in the optical modules.



*Possibility of equipment damage. Risk of eye damage by laser radiation.*

Per CDRH 21 CFR 10.40.10 (h) (1) (iv) distributors of Class 1 laser products, such as Nokia ONTs shall leave the following Laser Safety cautions with the end user.

- a) "Class 1 Laser Product"
- b) "Caution – Use of controls or adjustments or performance of procedures other than those specified herein may result in hazardous radiation exposure."

#### 4.3.1 Laser warning labels

The following figures show sample labels related to laser product, classification and warning.

Figure 4-3, "Laser product label" (p. 38) shows a laser product label.

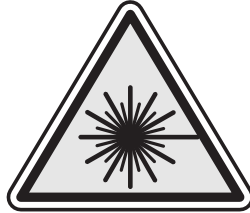
*Figure 4-3* Laser product label

18455

[Figure 4-4, “Laser classification label” \(p. 38\)](#) shows a laser classification label. Laser classification labels may be provided in other languages.

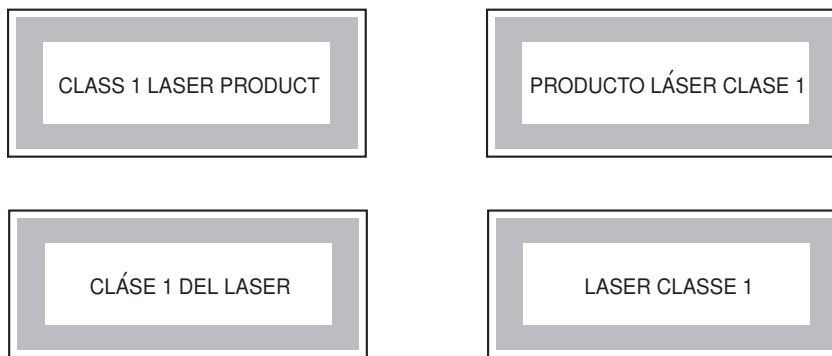
*Figure 4-4* Laser classification label

18992

[Figure 4-5, “Laser warning labels” \(p. 39\)](#) shows a laser warning label and an explanatory label for laser products. Explanatory labels may be provided in other languages. The explanatory label provides the following information:

- a warning that calls attention to the invisible laser radiation
- an instruction against staring into the beam or viewing directly with optical instruments
- wavelength
- normal output power
- maximum output power

Figure 4-5 Laser warning labels

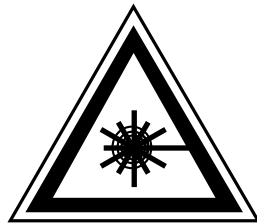

Laser Warning Label

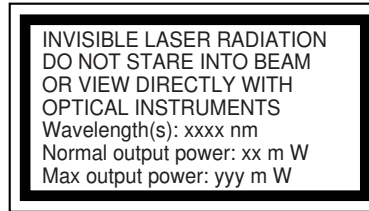

Laser Warning Label

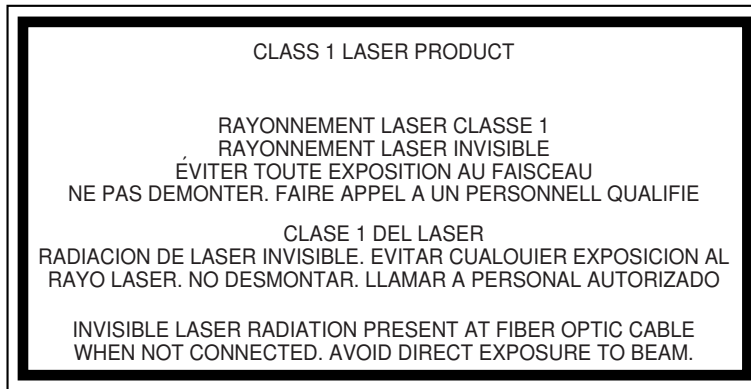

Laser Warning Label

18993

### 4.3.2 Laser classification

The ONT is classified as a Class 1 laser product based on its transmit optical output.

For Class 1 laser products, lasers are safe under reasonably foreseeable conditions of operation, including the use of optical instruments for intrabeam viewing.

[Figure 4-6, “Sample laser product safety label on the ONT equipment” \(p. 40\)](#) shows a sample laser product safety label on the ONT equipment.

Figure 4-6 Sample laser product safety label on the ONT equipment

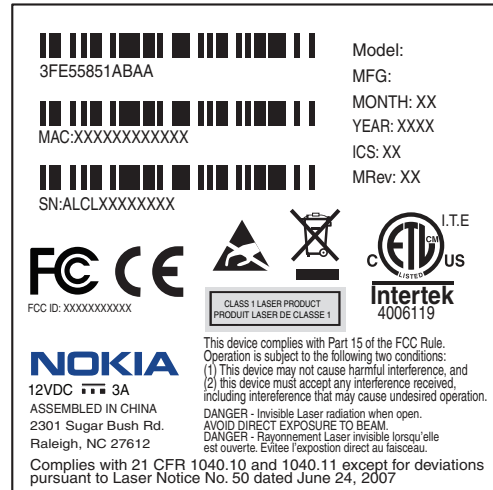

18532

### 4.3.3 Transmit optical output

The maximum transmit optical output of an ONT is +5 dBm.

### 4.3.4 Normal laser operation

In normal operation, fiber cable laser radiation is always off until it receives signal from the line terminal card.

Operating personnel must observe the instructions on the laser explanatory label before plugging in the optical module.



*Risk of eye damage by laser radiation.*

### 4.3.5 Location class

Use cable supports and guides to protect the receptacles from strain.

## 4.4 Electrical safety guidelines

This section provides the electrical safety guidelines for the ONT equipment.

**i** **Note:** The ONTs comply with the U.S. National Electrical Code. However, local electrical authorities have jurisdiction when there are differences between the local and U.S. standards.



#### 4.4.1 Power supplies

The use of any non-Nokia approved power supplies or power adapters is not supported or endorsed by Nokia. Such use will void any warranty or support contract with Nokia. Such use greatly increases the danger of damage to equipment or property.

#### 4.4.2 Cabling

The following are the guidelines regarding cables used for the ONT equipment:

- Use only cables approved by the relevant national electrical code.
- Use cables suitable for outdoor use for outdoor installation of ONTs.
- The ONTs have been evaluated for use with external POTS wiring without primary protection that may not exceed 140 ft (43 m) in reach. However, the power cable must not exceed 100 ft (31 m).

#### 4.4.3 Protective earth

Earthing and bonding of the ONTs must comply with the requirements of NEC article 250 or local electrical codes.

### 4.5 ESD safety guidelines

The ONT equipment is sensitive to ESD. Operations personnel must observe the following ESD instructions when they handle the ONT equipment.



#### CAUTION

##### Service Disruption

*This equipment is ESD sensitive. Proper ESD protections should be used when entering the TELCO Access portion of the ONT.*

During installation and maintenance, service personnel must wear wrist straps to prevent damage caused by ESD.

Nokia recommends that you prepare the site before you install the ONT equipment. In addition, you must control relative humidity, use static dissipating material for furniture or flooring, and restrict the use of air conditioning.

### 4.6 Environmental requirements

See the ONT technical specification documentation for temperature ranges for ONTs.

During operation in the supported temperature range, condensation inside the ONT caused by humidity is not an issue. To avoid condensation caused by rapid changes in temperature and humidity, Nokia recommends:

- The door of the ONT not be opened until temperature inside and outside the enclosure has stabilized.
- If the door of the ONT must be opened after a rapid change in temperature or humidity, use a dry cloth to wipe down the metal interior to prevent the risk of condensation.

- 
- When high humidity is present, installation of a cover or tent over the ONT helps prevent condensation when the door is opened.

## 5 XS-2426G-B unit data sheet

### 5.1 Overview

#### 5.1.1 Purpose

#### 5.1.2 Contents

5.1 Overview	43
5.2 XS-2426G-B part numbers and identification	43
5.3 XS-2426G-B general description	45
5.4 XS-2426G-B software and installation feature support	51
5.5 XS-2426G-B interfaces and interface capacity	51
5.6 XS-2426G-B LEDs	53
5.7 XS-2426G-B detailed specifications	55
5.8 XS-2426G-B GEM ports and T-CONTs	56
5.9 XS-2426G-B performance monitoring statistics	56
5.10 XS-2426G-B functional blocks	57
5.11 XS-2426G-B standards compliance	58
5.12 XS-2426G-B special considerations	60

### 5.2 XS-2426G-B part numbers and identification

Table 5-1, “Identification of XS-2426G-B indoor ONTs” (p. 43) provides part numbers and identification information for the XS-2426G-B indoor ONT.

Table 5-1 Identification of XS-2426G-B indoor ONTs

Ordering kit part number	Provisioning number	Description	CLEI Code	CPR	ECI/ Bar code
3FE 49542 AB	3FE 49546 AB	XS-2426G-B, XGS-PON ONT supports 2 POTS ports, 3xGE+1X2, 5GE UNI, 4x4+4x4 11ax. Includes one USB 3.0 Type A ports and a 12V 3A wall mounted AC/DC power adapter with 2-pin US input plug	—	—	—
3FE 49542 BA	3FE 49546 BA	XS-2426G-B, XGS-PON ONT supports 2 POTS ports, 3xGE+1x2, 5GE UNI, 4x4 +4x4 11ax. Includes one USB 3.0 Type A ports and a 12V 3A wall mounted AC/DC power adapter with 2-pin EU input plug	—	—	—

Table 5-1 Identification of XS-2426G-B indoor ONTs (continued)

Ordering kit part number	Provisioning number	Description	CLEI Code	CPR	ECI/ Bar code
3FE 49542 BB	3FE 49546 BB	XS-2426G-B, XGS-PON ONT supports 2 POTS ports and Delta fiber, 3xGE+1x2, 5GE UNI, 4x4 +4x4 11ax. Includes one USB 3.0 Type A ports and a 12V 3A wall mounted AC/DC power adapter with 2-pin EU input plug	—	—	—
3FE 49542 CA	3FE 49546 CA	XS-2426G-B, XGS-PON ONT supports 2 POTS ports, 3xGE +1x2 UNI, 5GE UNI 4x4+4x4 11ax. Includes one USB 3.0 Type A ports and a 12V 3A wall mounted AC/DC power adapter with 3-pin UK input plug with UKCA compliance certification.	—	—	—

Table 5-2, “XS-2426G-B power supply ordering information” (p. 44) provides the power supply information for the XS-2426G-B ONT. For more information on power supplies, see the **Nokia ONT Power Supply and UPS Guide**.

Table 5-2 XS-2426G-B power supply ordering information

ONT part numbers	Power information (Model No./Manufacture Part Number)	Power information	Customer category or country compliance tested for	Notes
3FE 49542 AB EMA: 3FE 49546 AB	FUHUA:UES36WU-120300SPA/ UE191205GWZF2RI HONOR:ADS-40FKJ-12N 12036EPCU/ 9040108111201202R	12V 3A wall mounted AC/DC power adapter with 2-pin US input plug	ANSI municipality US, Canada UL/ETL IEC62368-1 FCC/CB	2-pin US input plug
Kit: 3FE 49542 BA EMA: 3FE 49546 BA	FUHUA:UES36WV-120300SPA/ UE191205GWZF1RI HONOR:ADS-40FKJ-12N 12036EPG/ 9040108111202201R	12V 3A wall mounted AC/DC power adapter with 2-pin EU input plug	Europe CE/CB	2-pin EU input plug
3FE 49542 BB EMA:3FE 49546 BB	HONOR:ADS-40FKJ-12N 12036EPG/ 9040108111202201R	12V wall mounted AC/DC power adapter with 2-pin EU input plug	Europe CE/CB	2-pin EU input plug
Kit: 3FE 49542 CA EMA: 3FE49542CA	FUHUA:UES36WB-120300SPA/ UE191205GWZF3RI HONOR:ADS-40FKJ-12N 12036EPB/ 9040108111206201R	12V/3A wall mounted AC/DC power adapter with 3-pin UK input plug	Europe CE/CB	3-pin UK input plug

Table 5-3, “Hardware parts required for XS-2426G-B installations” (p. 45) lists the hardware parts required for mounting an XS-2426G-B ONT.

Table 5-3 Hardware parts required for XS-2426G-B installations

Part	Description
ONT unit	The XS-2426G-B ONT.
Wall mount bracket (3FE 49471 AA)	The wall mount bracket is fastened to a wall. The XS-2426G-B ONT is seated in the wall mount bracket. With white color, 1 pc per box.
Wall mount bracket (3FE 49471 AB)	The wall mount bracket is fastened to a wall. The XS-2426G-B ONT is seated in the wall mount bracket. With black color, 72 pcs per box.
Wall mount bracket (3FE 49471 AC)	The wall mount bracket is fastened to a wall. The XS-2426G-B ONT is seated in the wall mount bracket. With white color, 72 pcs per box.
Mounting screws	Two screws are required to mount the wall mount bracket. The recommended screw is a M4 or #6 screw with a pan head style of screw head.

### 5.3 XS-2426G-B general description

XS-2426G-B indoor ONTs provide the subscriber interface for the network by terminating the PON interface and converting it to user interfaces that directly connect to subscriber devices.

The XS-2426G-B has built-in Wi-Fi 802.11 b/g/n/ac/ax networking with triple play capability and can provide triple play services with voice, video and data.

The ONT is compatible with all existing subscriber equipment, including analog phones with both tone and rotary dial capabilities, cordless phones, modems, fax machines, and caller ID boxes (Type I, Type II, and Type III).

The ONT can be placed on a flat surface, such as a desk or shelf.

Figure 5-1 XS-2426G-B ONT

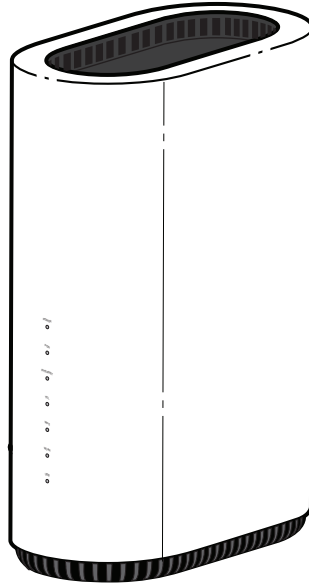

36995

XS-2426G-B indoor ONTs provide the following functions:

- Dual-band concurrent 4x4 802.11b/g/n/ac/ax 2.4 GHz and 4x4 802.11ac/ax MU-MIMO 5 GHz
- Supports 802.11b/g/n/ac/ax 4x4 Wireless 2.4 GHz MIMO; Channel bandwidth 20, 40 MHz, auto
- Supports 802.11ac/ax 4x4 Wireless 5 GHz Mu-MIMO; Channel bandwidth 20, 40, 80 MHz, auto
- Four Gigabit standard RJ-45 1000/100/10 Mbps, auto negotiating Ethernet ports and MDI/MDIX auto sensing
- Two POTS ports with R-J11 connectors
- One USB 3.0 Type A ports
- XGS-PON Uplink, G.9807.1, G.988 series standard compliant
- 256 MB NAND Flash with bad block management, 512 MB DDR3 RAM, pin2pin compatible design for possible upgrade of RAM/Flash
- Four RJ-45 1000/100/10 Ethernet ports with auto negotiation and MDI/MDIX auto sensing
- WLAN on/off push button
- WPS on/off push button
- LEDs on/off push button
- Reset button
- Triple-Play services, including voice, video and high speed Internet access
- Support for fax services
- Built-in layer 2 switch; Line Rate L2 traffic
- IP video distribution

- Wavelength: 1577 nm downstream; 1270 nm upstream
- Supports WBF filter. The GPON ONTs can co-exist with XGSPON ONTs in the same PON.
- Line rate: 9.953 Gb/s downstream and upstream
- 2 inner antennas for 2.4G, 2 inner antennas for 5G
- Optics that support received signal strength indication (RSSI)
- Wireless 2.4 GHz 802.11b/g/n/ac/ax 2x2 MIMO
- Wireless 5 GHz 802.11ac/ax 2x2 MU-MIMO
- 64/128 WEP encryption
- WPA, WPA-PSK/TKIP
- WPA2, WPA2-PSK/AES
- WPA3, WPA3-SAE
- VLAN tagging/detagging and marking/remarking of IEEE 802.1p per Ethernet port.
- Dying gasp support
- Voice Services via Session Initiation Protocol (SIP)
- Multiple voice Code
- DTMF dialing
- Echo cancellation (G.168)
- Fax mode configuration (T.30/T.38)
- Caller ID, call waiting, call hold, 3-way calling, call transfer, message waiting
- Forward Error Correction (FEC)
- support for multiple SSIDs (private and public instances); contact your Nokia representative for further details.
- Conductive power: 250 mW/24 dBm (2.4 GHz); 500 mW/27 dBm (5 GHz)
- Maximum effective isotropic radiated power (EIRP): 500 mW/27 dBm (2.4 GHz); 1000 mW/30 dBm (5 GHz)
- Bridged mode or routed mode per LAN port
- Ethernet-based Point-to-Point (PPPoE)
- DHCP client/server
- DNS server/client
- DDNS
- Port forwarding
- Network Address Translation (NAT)
- Network Address Port Translation (NAPT)
- UPnP IGD2.0 support
- ALG
- IGMP snooping and proxy (v2/v3)
- Traffic classification and QoS capability

- OMCI/TR-069 Web GUI configuration
- Performance monitoring and alarm reporting
- Remote software image downloading and activation
- IP/MAC/URL filter
- Multi-level firewall and ACL

### 5.3.1 TR-069 parameter support

The XS-2426G-B ONT supports the following TR-069 features:

- Host object
- Port forwarding
- Optical parameters
- Object support for WiFi parameters
- Statistics and troubleshooting
- Diagnostic parameters

#### Host object support

The ONT provides host object support for: InternetGatewayDevice.LANDevice.Hosts.Host.

#### Port forwarding support

The ONT supports the port forwarding of objects via TR-069:

- Application Name
- WAN Port
- LAN Port
- Internal Client
- Protocol
- Enable Mapping
- WAN Connection List

These are the same port forwarding parameters supported in the GUI. For more information, see [Table 8-33, "Port Forwarding parameters" \(p. 128\)](#) in [Chapter 8, "Configure a XS-2426G-B indoor ONT"](#).

#### Optical parameters support

The ONT supports the reading of optical parameters via TR-069:

- Laser bias current
- Voltage
- Temperature
- Received signal levels
- Lower thresholds



These are the same optical parameters supported in the GUI. For more information, see [Table 8-9, “Optics Module Status parameters”](#) (p. 94) in [Chapter 8, “Configure a XS-2426G-B indoor ONT”](#).

#### **Object support for WiFi parameters**

The ONT supports the status retrieval and configuration of the following Wi-Fi parameters via TR-069:

- Channel
- SSID
- Password for WPA and WEP
- Tx power (transmission rate in percentage of maximum transmit power)
- WPS

These are the same TR-069 object parameters that are supported in the GUI. For more information, see [Table 8-15, “Wireless \(2.4GHz\) parameters”](#) (p. 105) and [Table 8-16, “Wireless \(5GHz\) parameters”](#) (p. 107) in [Chapter 8, “Configure a XS-2426G-B indoor ONT”](#).

#### **Statistics and troubleshooting support**

The ONT supports TR-069 statistics and troubleshooting for LAN, WAN, and WiFi.

For more information, see the Procedure [8.58 “Viewing Residential Gateway \(RG\) troubleshooting counters”](#) (p. 144) in [Chapter 8, “Configure a XS-2426G-B indoor ONT”](#).

#### **Diagnostic parameter support**

The ONT supports the following TR-069 diagnostic parameters:

- TR-143
- IP ping
- Traceroute

These are the same diagnostic parameters supported in the GUI. For more information, see the Procedure [8.55 “Diagnosing WAN connections”](#) (p. 141) in [Chapter 8, “Configure a XS-2426G-B indoor ONT”](#).

### **5.3.2 TR69 authentication using TLS and CA certificates**

XS-2426G-B ONTs support TLS, as well as ACS authentication using SHA-256 pre-installed certificates.

If the URL is set to the https://... format, by default, the connection will use TLS without authentication mode. The ONT can also authenticate the ACS using a pre-installed CA certificate.

The XS-2426G-B ONTs support TLSv1.3 for TR069. The ONT supports download certification from ACS.

### **5.3.3 TR-104 parameter extension support for voice service**

A vendor specific attribute has been added to the TR-104 Voice Service object structure to enable the ACS to configure the name of the embedded GSIP XML file to be selected.

The TR-104 Voice Service Object is:  
InternetGatewayDevice.Services.VoiceService.{i}.Capabilities.SIP.

The vendor specific attribute is: X\_ALU-COM\_XML\_File\_Name\_Path.

### 5.3.4 TR-104 voice-related alarms

The XS-2426G-B ONT supports the following four TR-104 voice-related alarms on a per FXS port basis.

These alarms all represent SIP registration failures with an alarm level of MAJOR.

- SIPREGDNS: domain name could not be resolved
- SIPREGAUTH: authentication failed
- SIPREGTO: re-transmissions timed out
- SIPREGERR: error response from the registration server

### 5.3.5 TR-104 parameters for FX line testing

New attributes have been added to the TR-104 Voice Service object structure to enable the ACS to perform line tests. The ONT supports the following electrical line tests:

- Hazardous potential
- Foreign electrical motive force
- Resistive faults
- Receiver off-hook test
- Ringers test

### 5.3.6 TR-111 support

The XS-2426G-B ONT supports TR-111, which extends the WAN Management Protocol defined in TR-069 to enhance the ability to remotely manage LAN devices.

The device-gateway association enables an ACS to identify the associated gateway through which a device is connected.

A connect request via the NAT gateway enables an ACS to initiate a TR-069 session with a device that is operating behind a NAT gateway.

### 5.3.7 TR-157 support

The ONT can support LXC container for third party software components on ONTs with minimal 512 M memory. These software components are managed by ACS with the parameters defined in TR-157.

The TR-157 objects are:

- Manage each software component via SoftwareModules.DeploymentUnit.{i}
- Set software component execution environment via SoftwareModules.ExecEnv.{i}
- Run software component and get the execution status via SoftwareModules.ExecutionUnit.{i}

**i** **Note:** The device reserves and limits to 64 MB RAM and 32 MB flash in total for all of the third

party applications. The maximum CPU load created or provided to the third party application is limited to approximately 30%. Underlying non-priority processes may still use the remaining memory on a temporary basis.

Nokia can assist to review specific applications, taking into account the actual memory load of the current hardware, current and projected software evolution over time, and the projected use by a third party application of the software.

## 5.4 XS-2426G-B software and installation feature support

For information on installing or replacing the XS-2426G-B see:

- [Chapter 6, “Install a XS-2426G-B indoor ONT”](#)
- [Chapter 7, “Replace a XS-2426G-B indoor ONT”](#)

For information on the following topics, see the **Nokia ONT Product Overview Guide**:

- ONT and MDU general descriptions of features and functions
- Ethernet interface specifications
- POTS interface specifications
- RSSI specifications
- Wi-Fi specifications
- ONT optical budget
- SLID entry via Ethernet port
- ONT management using an ONT interface

## 5.5 XS-2426G-B interfaces and interface capacity

[Table 5-4, “XS-2426G-B indoor ONT interface connection capacity” \(p. 51\)](#) describes the supported interfaces and interface capacity for XS-2426G-B indoor ONTs.

Table 5-4 XS-2426G-B indoor ONT interface connection capacity

ONT type and model	Maximum capacity								
	POTS	100/ 10 BASE-T	1000/ 100/ 10 BASE-T	RF video (CATV)	MoCA	VDSL2	E1/T1	Local craft	XGSPON SC/APC
XS-2426G-B <sup>1</sup>	2	—	4	—	—	—	—	—	1

### Notes:

1. The XS-2426G-B ONTs provide Wi-Fi service that is enabled and disabled using a Wi-Fi on/off switch.

### 5.5.1 XS-2426G-B connections and components

[Figure 5-2, “XS-2426G-B indoor ONT physical connections \(back\)” \(p. 52\)](#) shows the physical connections for XS-2426G-B indoor ONTs.

Figure 5-2 XS-2426G-B indoor ONT physical connections (back)

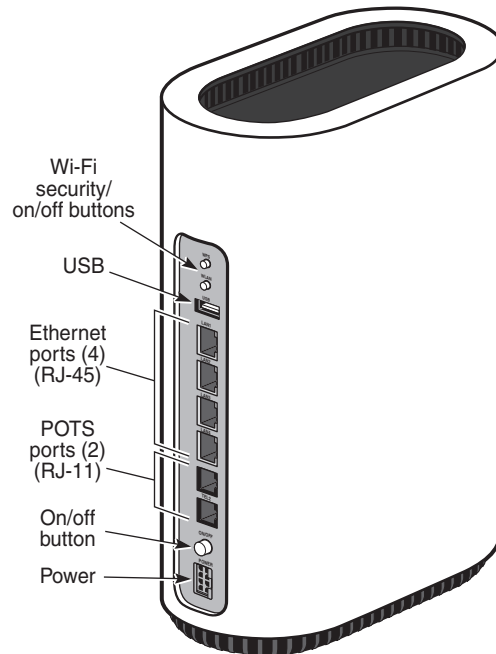

36736

Table 5-5, “XS-2426G-B indoor ONT physical connections” (p. 52) describes the physical connections for XS-2426G-B indoor ONTs.

Table 5-5 XS-2426G-B indoor ONT physical connections

Connection <sup>1</sup>	Print Letters	Description
POTS port	TEL1 and TEL2	This connection is provided through an RJ-11 port. One POTS connection is supported. The POTS port supports voice services.
Ethernet ports	LAN1 to LAN4	This connection is provided through Ethernet RJ-45 connectors. Up to four 1000/100/10 Base-T Ethernet interfaces are supported. The Ethernet ports can support both data and in-band video services on all four interfaces.
Power input	POWER	This connection is provided through the power connector. A power cable fitted with a barrel connector is used to make the connection.
Reset button	RESET	Pressing the Reset button for less than 10 seconds reboots the ONT; pressing the Reset button for 10 seconds resets the ONT to the factory defaults, except for the LOID and SLID.
WLAN button	WLAN	Wi-Fi service is compliant with IEEE 802.11 standards and is enabled and disabled using the WLAN button.
WPS button	WPS	The Wi-Fi Protected Setup (WPS) button enables and disables the WPS.
LED button	LED	The LED button turns the LED indicators on or off.
On/Off button	ON/OFF	This button turns the ONT on or off.

Table 5-5 XS-2426G-B indoor ONT physical connections (continued)

Connection <sup>1</sup>	Print Letters	Description
USB port	USB	This connection is provided through 1 USB port on the side of the ONT. The ONT supports external USB hard drives that can be made accessible to all LAN devices.
Fiber optic port		The SC/APC fiber optic port is located at the back of the ONT and provides the connection for the fiber optic cable.

**Notes:**

1. The primary path for the earth ground for these ONTs is provided by the 12V Return signal in the power connector.

## 5.6 XS-2426G-B LEDs

Figure 5-3, “XS-2426G-B indoor ONT LEDs” (p. 53) shows the XS-2426G-B indoor ONT LEDs.

Figure 5-3 XS-2426G-B indoor ONT LEDs

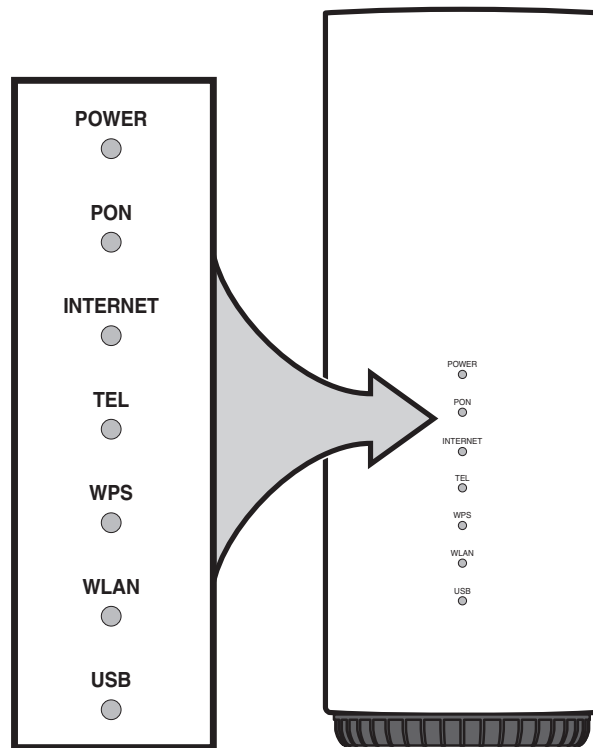

36997

Table 5-6, “XS-2426G-B indoor ONT LED descriptions” (p. 54) provides LED descriptions for XS-2426G-B indoor ONTs.

Table 5-6 XS-2426G-B indoor ONT LED descriptions

Indicator	LED color and behavior	LED behavior description
Power	Green solid	Power on
	Blinking green	Software team to update Power off
	Red solid	Light failed on startup (for example corrupt flash), or self test failed on startup, or self test failed during regular operation or when executed over OMCI
	Off	Power off
PON	Off	No fiber connected or no Rx power (the power in dBm of the received signal)
	Solid Green	ONT has been configured on the OLT and is in service (UP)
	Flashing Green	ONT is attempting to range with OLT
	solid Red	GPON is down or no link connected.
INTERNET	Green solid	HSI WAN is connected: a) the device has an IP address assigned from IPCP, DHCP, or static; b) the session is dropped due to idle timeout but the PON link is still present, or transmit and receive traffic is ongoing.
	Green Flashing	PPPoE or DHCP connection is in progress.
	Off(Dark)	HSI WAN is not connected: a) there is no physical interface connection; b) the device is in bridged mode without an assigned IP address; c) the session has been dropped for reasons other than idle timeout.
TEL	Green Solid	at one Phone is off hook and voip service is build up.
	Flashing Green	Phone is in 'call in' or 'talking' condition
	Red	VOIP service is out of service
	Off	All phones are on hook, VOIP service is not built up
WPS	Green Solid	WiFi protected setup link is up (negotiation and auto-configuration successful)
	Green Flashing	WiFi protected setup link activity (negotiation and auto-configuration ongoing)
	Red Solid	WiFi protected setup processing exception or multiple peers using WPS simultaneously
	Off	WiFi protected setup link down or no link connected (negotiation has not started or has failed)
WLAN	Green solid	WiFi enabled for at least one radio frequency (RF)
	Off(dark)	WLAN is down
LAN/RJ45 (Executed on the RJ45 connectors)	Green Solid	LAN link active
	OFF	LAN link is OFF or has LOS (line of sight) transmission issue.
USB	Green solid	At least one device is connected to the USB port
	Green flashing	There is traffic activity on at least one device connected to the USB port
	Off	No device is connected to the USB port

## 5.7 XS-2426G-B detailed specifications

The following table lists the physical specifications for XS-2426G-B indoor ONTs.

Table 5-7 XS-2426G-B indoor ONT physical specifications

Description	Specification
Depth	6.29 in. (160 mm)
Width	3.34 in. (85 mm)
Height (including antenna)	8.85 in. (225 mm)
Weight [within ± 0.5 lb (0.23 kg)] (net weight of ONT)	2.204 lbs (4.85 g)

Table 5-8, “XS-2426G-B dimension data specifications” (p. 55) lists the dimension data specifications for XS-2426G-B ONT

Table 5-8 XS-2426G-B dimension data specifications

Dimension	Specification
Packet size supported	Less than 2000 jumbo frames
Number of IP addresses supported (or ranges)	In LAN network, the supported range is: <ul style="list-style-type: none"> <li>• IPv4: 192.168.0.2 ~ 192.168.0.253 (default)</li> <li>• IPv6: no limitation</li> </ul>
Number of supported Wi-Fi clients (per radio, per device, per mesh)	128 per radio, 256 per device, 256 clients supported
Number of supported beacons /APs in a mesh	6 (including device itself)
Number of supported WAN interfaces	Supports 6 WAN connection: WAN - Router: <ul style="list-style-type: none"> <li>• Connection Type: IPoE</li> <li>• Service: INTERNET</li> <li>• WAN IP Mode: DHCP</li> </ul>
Number of supported VLANs	Supports 6 VLANs. Supports only untagged packets in upstream.
Number of priority queues, and overall buffer size	64 priority queues. Max 16MB for WAN and 4MB for LAN
Number of multicast groups (DAACL entries)	64

Table 5-9, “XS-2426G-B indoor ONT power consumption specifications” (p. 56) lists the power consumption specifications for XS-2426G-B indoor ONT.

Table 5-9 XS-2426G-B indoor ONT power consumption specifications

Mnemonic	Maximum power (Not to exceed)	Condition	Minimum power	Condition
XS-2426G-B	30 W	2 POTS 5REN, 4 1000/100/10 Base-T Ethernet, Wi-Fi operational, USB operational	9.6 W	Wi-Fi beacon, other interface/service not provisioned

Table 5-10, “XS-2426G-B indoor ONT environmental specifications” (p. 56) lists the environmental specifications for XS-2426G-B indoor ONT.

Table 5-10 XS-2426G-B indoor ONT environmental specifications

Mounting method	Temperature range and humidity	Altitude
On desk or shelf	Operating: 23°F to 113°F (-5°C to 45°C) ambient temperature 90% humidity at 40°C	Contact your Nokia technical support representative for more information
	Storage: -4°F to 158°F (-20°C to 70°C)	

## 5.8 XS-2426G-B GEM ports and T-CONTs

Table 5-11, “XS-2426G-B indoor ONT capacity for GEM ports and T-CONTs” (p. 56) lists the maximum number of supported T-CONTs and GEM ports. See the appropriate release Customer Release Notes for the most accurate list of supported devices.

Table 5-11 XS-2426G-B indoor ONT capacity for GEM ports and T-CONTs

ONT or MDU	Maximum	Notes
<b>Package P ONTs</b>		
GEM ports per indoor or outdoor ONT	256	256 are present; 254 are available, and 2 are reserved for multicast and debugging
T-CONTs per indoor or outdoor ONT	32	32 are present; 31 are available, and 1 is reserved for OMCI

## 5.9 XS-2426G-B performance monitoring statistics

The following section identifies the supported performance monitoring statistics for the XS-2426G-B. A check mark indicates the statistic is supported on that ONT. An empty cell indicates the statistic is not supported. A cell without a check mark indicates the counter is not applicable to that type of ONT. The following tables are categorized by supported counters types:

- Table 5-12, “XS-2426G-B ONT generic performance monitoring statistics” (p. 57) provides statistics for generic ONT type counters
- Table 5-13, “XS-2426G-B ONT ONTL2UNI performance monitoring statistics” (p. 57) provides statistics for ONTL2UNI type counters



Table 5-12 XS-2426G-B ONT generic performance monitoring statistics

ONT	Generic statistics	
	CPU	Memory utilization
XS-2426G-B	✓	✓

Table 5-13 XS-2426G-B ONT ONTL2UNI performance monitoring statistics

ONT	ONTL2UNI statistics						
	FRAMES	BYTES	MCFRAMES	DSDRPFRRMS	DSCRCERRORFRAMES	USDRPFRRMS	USCRCERRORFRAMES
XS-2426G-B	✓	✓	✓	✓	✓	✓	✓

## 5.10 XS-2426G-B functional blocks

XS-2426G-B indoor ONTs are single-residence ONTs that support Wireless (Wi-Fi) service. Wi-Fi service on these ONTs is compliant with the IEEE 802.11 standard and enabled or disabled using a WLAN button. In addition to the Wi-Fi service, these ONTs transmit Ethernet packets to four RJ-45 Ethernet ports and voice traffic to two RJ-11 POTS port. These ONTs also feature fiber optic, USB, and power connectors.

[Figure 5-4, “XS-2426G-B ONT functional block” \(p. 58\)](#) shows the functional blocks for XS-2426G-B indoor ONT.

Figure 5-4 XS-2426G-B ONT functional block

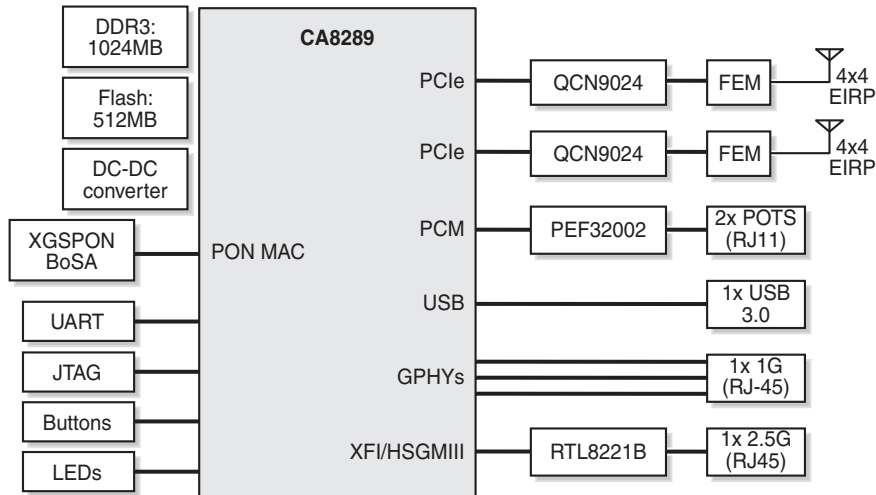

37000

## 5.11 XS-2426G-B standards compliance

XS-2426G-B indoor ONTs are compliant with the following standards:

- CE marking for European standards for health, safety, and environmental protection
- EN 300-328 v1.9.1 wide band data transmission standards for 2.4GHz bands
- G.984 support GPON interface (framing)
- G.984.2 (Amd1, class B+) for GPON
- G.984.3 support for activation and password functions
- G.984.3 support for AES with operator enable/disable on per port-ID level
- G.984.3 support for dynamic bandwidth reporting
- G.984.3 support for FEC in both upstream and downstream directions
- G.984.3 support for multicast using a single GEM Port-ID for all video traffic
- G.984.4 and G.983.2 support for ONT management and provisioning
- IEEE 802.1p for traffic prioritization
- IEEE 802.1q for VLANs
- IEEE 802.3 (2012)
- IEEE 802.11b/g/b/ac/ax for WIFI
- ITU-T G.711, G.722, G.723, G.726, G.729
- SIP RFC 3261

### 5.11.1 Responsible party

The following lists the party in the US responsible for this ONT.

Table 5-14 Responsible party contact information

Legal Company name	Nokia Solutions and Networks OY	Nokia of America Corporation
Offices	<a href="https://www.nokia.com/contact-us/offices/#north-america">Offices   Nokia (https://www.nokia.com/contact-us/offices/#north-america)</a>	
Support	<a href="https://www.nokia.com/networks/business-support/">Business Support   Nokia (https://www.nokia.com/networks/business-support/)</a>	
Other contacts	<a href="https://www.nokia.com/contact-us/">Contact us   Nokia (https://www.nokia.com/contact-us/)</a>	

### 5.11.2 Energy-related products standby and off modes compliance

Hereby, Nokia declares that the XS-2426G-B ONTs are in compliance with the essential requirements and other relevant provisions of Directive 2009/125/EC together with Commission Regulation (EC) No 1275/2008 and Commission Regulation (EC) No 801/2013.

The XS-2426G-B ONTS qualify as equipment with high network availability (HiNA) functionality. Since the main purpose of XS-2426G-B ONTs is to provide network functionality with HiNA 7 days /24 hours, the modes Off/Standby, Power Management, and Networked Standby are inappropriate.

For information about the type and number of network ports, see 5.5 “XS-2426G-B interfaces and interface capacity” (p. 51) in this chapter.

For information about power consumption, see 5.7 “XS-2426G-B detailed specifications” (p. 55) in this chapter.

### 5.11.3 FCC statement

This equipment has been tested and found to comply with the limits for a Class B digital device, pursuant to part 15 of the FCC Rules. These limits are designed to provide reasonable protection against harmful interference in a residential installation. This equipment generates, uses and can radiate radio frequency energy and, if not installed and used in accordance with the instructions, may cause harmful interference to radio communications. However, there is no guarantee that interference will not occur in a particular installation. If this equipment does cause harmful interference to radio or television reception, which can be determined by turning the equipment off and on, the user is encouraged to try to correct the interference by one or more of the following measures:

- Reorient or relocate the receiving antenna.
- Increase the separation between the equipment and receiver.
- Connect the equipment into an outlet on a circuit different from that to which the receiver is connected.
- Consult the dealer or an experienced radio/TV technician for help.

### 5.11.4 FCC Radiation Exposure Statement

This device complies with FCC radiation exposure limits set forth for an uncontrolled environment and it also complies with Part 15 of the FCC RF Rules. This equipment must be installed and operated in accordance with provided instructions and the antenna(s) used for this transmitter must

be installed to provide a separation distance of at least 20 cm from all persons and must not be co-located or operating in conjunction with any other antenna or transmitter. End-users and installers must be provided with antenna installation instructions and consider removing the no-collocation statement.

This device complies with Part 15 of the FCC Rules. Operation is subject to the following two conditions:

1. This device may not cause harmful interference, and
2. This device must accept any interference received, including interference that may cause undesired operation.



### CAUTION

#### Service Disruption

*Any changes or modifications not expressly approved by the party responsible for compliance could void the user's authority to operate the equipment.*

## 5.12 XS-2426G-B special considerations

XS-2426G-B is a package P ONT.

### 5.12.1 Wi-Fi service

XS-2426G-B indoor ONTs feature Wi-Fi service as well as voice and data services. Wi-Fi is a wireless networking technology that uses radio waves to provide wireless HSI and network connections. This ONT complies with the IEEE 802.11 standards, which the Wi-Fi Alliance defines as the basis for Wi-Fi technology.

#### Wi-Fi physical features

XS-2426G-B indoor ONTs have the following physical features that assist in providing Wi-Fi service:

- 1 WLAN button for enabling and disabling Wi-Fi service
- 1 Wi-Fi Protected Setup (WPS) push button for adding WPS-enabled wireless devices
- 4 internal antennas: 2x2 for 2.4G and 2x2 for 5G

#### Wi-Fi standards and certifications

The Wi-Fi service on XS-2426G-B indoor ONTs supports the following IEEE standards and Wi-Fi Alliance certifications:

- Certified for IEEE 802.11ac/b/g/n/standards
- WPA support including WPA-PSK
- Certified for WPA2-Personal
- Certified for WPA2-Enterprise
- Certified for WPA3-Personal
- Certified for WPA3-Enterprise

**Wi-Fi GUI features**

XS-2426G-B indoor ONTs have HTML-based Wi-Fi configuration GUIs.

**5.12.2 XS-2426G-B ONT considerations and limitations**

Table 5-15, “XS-2426G-B ONT considerations and limitations” (p. 60) lists the considerations and limitations for Package P XS-2426G-B ONTs.

Table 5-15 XS-2426G-B ONT considerations and limitations

Considerations and limitations
Call History Data collection (ONTCALLHST) is supported, except for the following parameters: RTP packets (discarded), far-end RTCP and RTCP-XR participation, RTCP average and peak round trip delay, MOS, average jitter, number of jitter-buffer over-runs and under runs.
Some voice features are configurable on a per ONT basis, including Call Waiting, Call Hold, 3-Way Calling, and Call Transfer.
<p>The following voice features / GSIP parameters are configurable on a per-Client/ per-ONT basis (not per-Subscriber):</p> <ul style="list-style-type: none"> <li>• Enable Caller ID and Enable Caller Name ID</li> <li>• Digitmap and the associated Interdigit and Critical timers and Enter key parameters</li> <li>• Warmline timer is enabled per subscriber, but the warmline timer value is configured per ONT and must have a lower value than the Permanent time</li> <li>• Miscellaneous timers: Permanent, Timed-release, Reanswer, Error-tone, and CW-alert timers</li> <li>• Features / functions: Message waiting mode, WMWI refresh interval, DTMF volume level</li> <li>• Service Codes for the following features: CW, Call Hold and Warmline</li> </ul>
<p>These feature items are only supported in the mesh root device or when the ONT works as a standalone device.</p> <ul style="list-style-type: none"> <li>• Domain group/isolation</li> <li>• Bridge WAN</li> <li>• VLAN binding</li> <li>• SoftGRE</li> <li>• QoS/Rate Limit per SSID and LAN port</li> </ul>



## 6 Install a XS-2426G-B indoor ONT

### 6.1 Overview

#### 6.1.1 Purpose

#### 6.1.2 Contents

<a href="#">6.1 Overview</a>	63
<a href="#">6.2 Purpose</a>	63
<a href="#">6.3 General</a>	63
<a href="#">6.4 Prerequisites</a>	63
<a href="#">6.5 Recommended tools</a>	63
<a href="#">6.6 Safety information</a>	64
<a href="#">6.7 Procedure</a>	64
<a href="#">6.8 Wall mount an XS-2426G-B indoor ONT</a>	67

### 6.2 Purpose

This chapter provides the steps to install a XS-2426G-B indoor ONT.

### 6.3 General

The steps listed in this chapter describe mounting and cabling for a XS-2426G-B indoor ONT.

### 6.4 Prerequisites

You need the following items before beginning the installation:

- all required cables

### 6.5 Recommended tools

You need the following tools for the installation:

- #2 Phillips screwdriver
- 1/4 in. (6 mm) flat blade screwdriver
- Wire strippers
- Fiber optic splicing tools
- RJ-45 cable plug crimp tool
- Voltmeter or multimeter

- Optical power meter
- Drill and drill bits
- paper clip

## 6.6 Safety information

Read the following safety information before installing the unit.



### DANGER

#### Hazard

*Hazardous electrical voltages and currents can cause serious physical harm or death. Always use insulated tools and follow proper safety precautions when connecting or disconnecting power circuits.*

*Make sure all sources of power are turned off and have no live voltages present on feed lines or terminals. Use a voltmeter to measure for voltage before proceeding.*

*Always contact the local utility company before connecting the enclosure to the utilities.*



### WARNING

#### Equipment Damage

*This equipment is ESD sensitive. Proper ESD protections should be used when removing the fiber access cover of the indoor ONT.*



### CAUTION

#### Service Disruption

*Keep indoor ONTs out of direct sunlight. Prolonged exposure to direct sunlight can damage the unit.*



**Note:** Observe the local and national laws and regulations that may be applicable to this installation.

Observe the following:

- The indoor ONT should be installed in accordance with the applicable requirements of the NEC or CEC. Local authorities and practices take precedent when there is conflict between the local standard and the NEC or CEC.
- The indoor ONT must be installed by qualified service personnel.
- Indoor ONTs must be installed with cables that are suitably rated and listed for indoor use.
- See the detailed specifications in the [Chapter 5, "XS-2426G-B unit data sheet"](#) for the temperature ranges of these ONTs.

## 6.7 Procedure

Use this procedure to install a XS-2426G-B indoor ONT.



1

Place the indoor ONT unit on a flat surface, such as a desk or shelf.



**Note:** The XS-2426G-B cannot be stacked with another ONT or with other equipment. The ONT mounting requirements are:

- allow a minimum 100 mm clearance above the top cover
- allow a minimum 50 mm clearance from the side vents
- do not place any heat source directly above the top cover or below the bottom cover

2

Review the connection locations, as shown in [Figure 6-1, "XS-2426G-B ONT connections" \(p. 64\)](#).

Figure 6-1 XS-2426G-B ONT connections

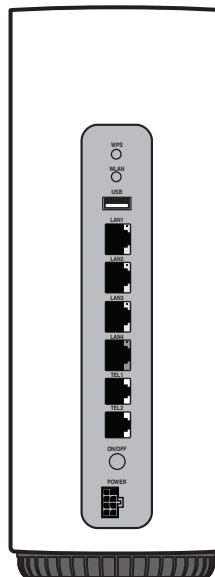

36993

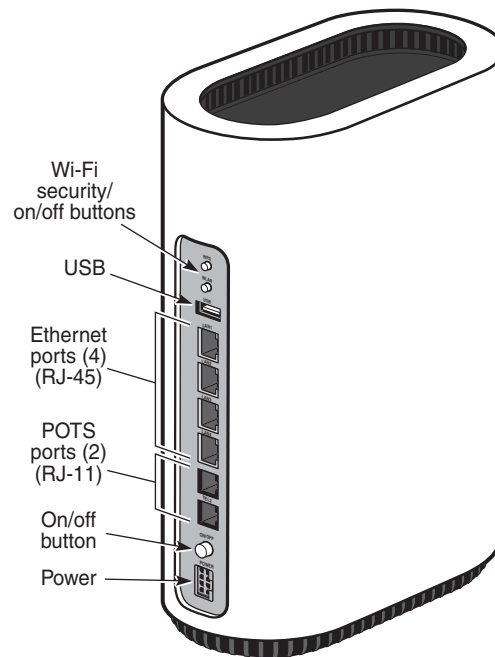

36736

3

Connect the Ethernet cables to the RJ-45 ports.

4

Route the POTS cable directly to the RJ-11 port as per local practices.

5

**DANGER****Hazard**

*Fiber cables transmit invisible laser light. To avoid eye damage or blindness, never look directly into fibers, connectors, or adapters.*

**WARNING****Equipment Damage**

*Be careful to maintain a bend radius of no less than 1.5 in. (3.8 cm) when connecting the fiber optic cable. Too small of a bend radius in the cable can result in damage to the optic fiber.*

---

Connect the fiber optic cable with SC/APC adapter to the SC/APC connector on the bottom of the ONT.

**i** **Note:** Fiber cable preparation varies depending on the type and size of the inside or outside plant fiber cable being spliced to the SC/APC fiber optic pigtail cable.

6

---

Connect the power cable to the power connector.

7

---

Power up the ONT unit by using the power switch.

8

---

If used, enable the Wi-Fi service.

- a. Locate the WLAN button on the ONT; see [Figure 6-1, “XS-2426G-B ONT connections” \(p. 65\)](#) for location of the WLAN button.
- b. Press the WLAN button to change the status of the Wi-Fi service.

9

---

Verify the ONT LEDs, voltage status, and optical signal levels; see the **Nokia ONT Hardware and Cabling Installation Guide**.

10

---

Activate and test the services; see the **Nokia ONT Hardware and Cabling Installation Guide**.

11

---

If necessary, reset the ONT.

- a. Locate the Reset button on a XS-2426G-B indoor ONT as shown in [Figure 6-1, “XS-2426G-B ONT connections” \(p. 65\)](#).
- b. Insert the end of a straightened paper clip or other narrow object into the hole in the Reset button to reset the ONT.

END OF STEPS

---

## 6.8 Wall mount an XS-2426G-B indoor ONT

This chapter provides the steps to mount an XS-2426G-B indoor ONT on a wall using a wall mount bracket (3FE 49471 AA). The XS-2426G-B indoor ONT is shipped without the wall mount bracket. The wall mount bracket (3FE 49471 AA) must be ordered separately.

Figure 6-2 XS-2426G-B ONT in wall mounting bracket

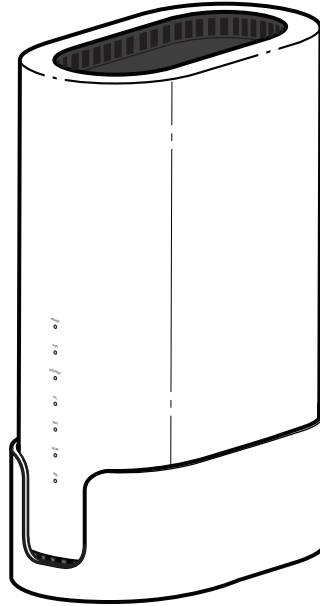

36994

### 6.8.1 Recommended tools

See section 6.5 “Recommended tools” (p. 63) for the recommended tools.

### 6.8.2 Procedure

Use this procedure to mount an XS-2426G-B ONT on a wall. Two installation options are available:

- Option 1—facing the room for the LEDs to be visible
- Option 2—facing the wall for the connectors and buttons to be visible

1

Place the indoor ONT unit:

- a. Facing the room, go to [Step 2](#). See [Figure 6-5, “ONT in wall mount bracket—facing the room”](#) (p. 71).
- b. Facing the wall, go to [Step 3](#). See [Figure 6-6, “ONT in wall mount bracket—facing the room / wall”](#) (p. 72).

2

Mount the ONT on a wall facing the room using the wall mount bracket (3FE 49471 AA), as shown in [Figure 6-3, “XS-2426G-B wall mount bracket”](#) (p. 69).

Figure 6-3 XS-2426G-B wall mount bracket

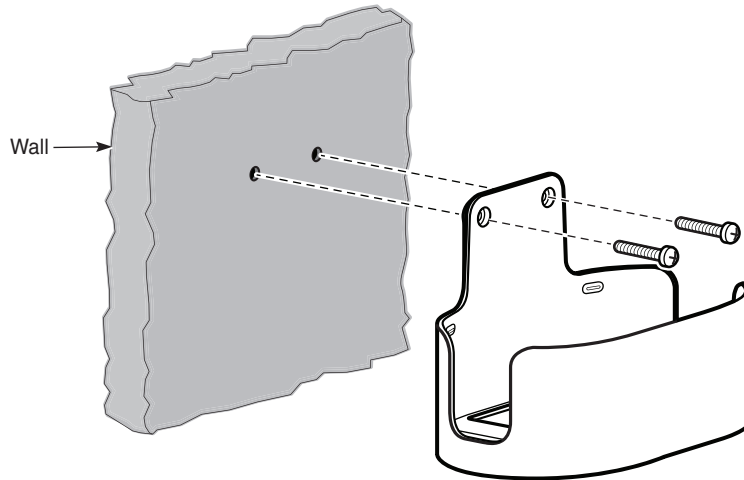

36747

- a. Determine the location of the two anchor holes for the wall mount bracket. The bracket can be used as a template for marking and drilling the holes.  
It is recommended to use a level to ensure that the ONT unit is installed properly.
- b. Drill two holes 35 mm (1.37 in.) depth into the wall and with the centers spaced 157 mm (6.2 in.).
- c. Insert the two mounting screws and optional anchors into the holes, leaving a 2 mm (0.078 in.) gap between the screw head and the wall.
- d. At this point, perform a test to ensure that the wall mount bracket fits securely over the screw heads. Mount the bracket flush to the wall so that it does not warp or twist.
- e. Remove the wall mount bracket from the wall.
- f. Route the power cord through the slot in the wall mount bracket. The ferrite bead on the power cord should remain on the underside of the wall mount bracket.
- g. Connect the power cord to the XS-2426G-B ONT.
- h. Install the ONT into the wall mount bracket by lifting the unit above the bracket and sliding it downward onto the bottom ledge of the bracket. See [Figure 6-4, "ONT to wall mount connection" \(p. 70\)](#).

Figure 6-4 ONT to wall mount connection

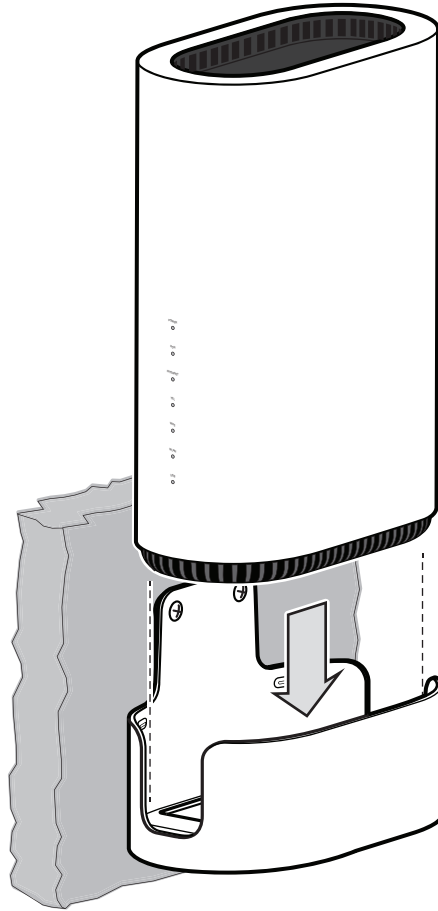

36748

- i. Seat the ONT into the wall mount bracket by engaging the hooks on the base of the unit with those on the bracket; see [Figure 6-5, “ONT in wall mount bracket—facing the room” \(p. 71\)](#). Engaging the hooks ensures that the ONT stays in place while the unit is mounted onto the wall.
- j. Connect the cables.
- k. Hang the unit onto the wall. [Figure 6-5, “ONT in wall mount bracket—facing the room” \(p. 71\)](#) shows the cables routed through the wall mount bracket and the ONT facing the room.

Figure 6-5 ONT in wall mount bracket—facing the room

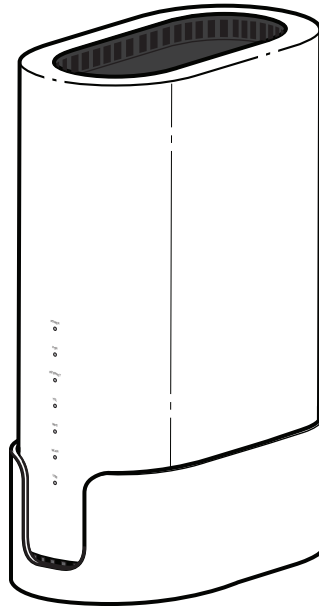

36994

3

Mount the ONT facing the wall using the wall mount bracket (3FE 49471 AA).

- a. Determine the location of the two anchor holes for the wall mount bracket. The bracket can be used as a template for marking and drilling the holes.  
It is recommended to use a level to ensure that the ONT unit is installed properly.
- b. Drill two holes 35 mm (1.37 in.) depth into the wall and with the centers spaced 157 mm (6.2 in.).
- c. Insert the two mounting screws and optional anchors into the holes, leaving a 2 mm (0.078 in.) gap between the screw head and the wall.
- d. At this point, perform a test to ensure that the wall mount bracket fits securely over the screw heads. Mount the bracket flush to the wall so that it does not warp or twist.
- e. Remove the wall mount bracket from the wall.
- f. On a flat surface such as a desk, install the ONT into the wall mount bracket by lifting the unit above the bracket and sliding it downward onto the bottom ledge of the bracket.
- g. Seat the ONT into the wall mount bracket by engaging the hooks on the base of the unit with those on the bracket. Engaging the hooks ensures that the ONT stays in place while the unit is mounted onto the wall.
- h. Mount the unit onto the wall.

- i. Connect the cables. See [Chapter 6, "Install a XS-2426G-B indoor ONT"](#).

[Figure 6-6, "ONT in wall mount bracket—facing the room / wall"](#) (p. 71) shows the mounted unit facing the wall with the cables (including the fiber) installed.

*Figure 6-6* ONT in wall mount bracket—facing the room / wall

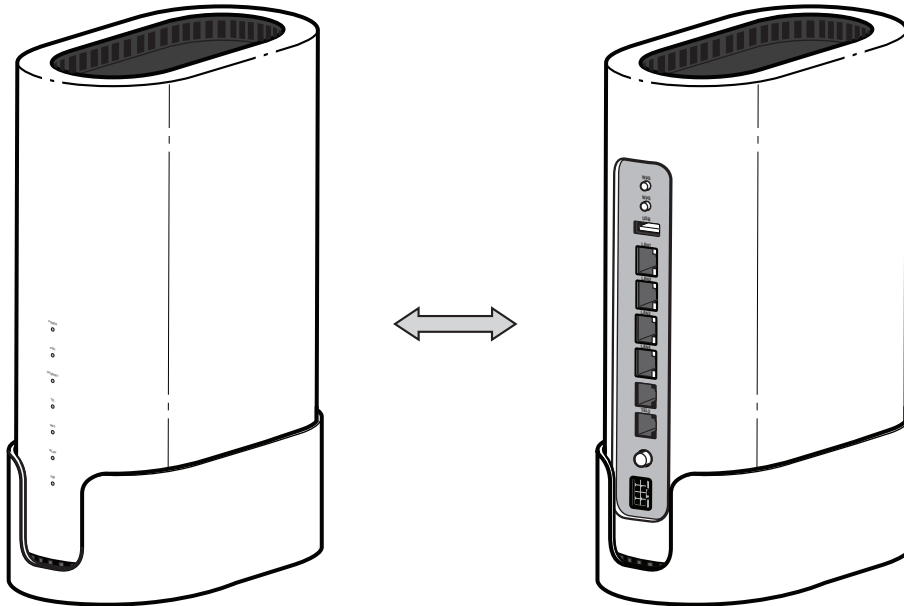

36749

END OF STEPS



## 7 Replace a XS-2426G-B indoor ONT

### 7.1 Overview

#### 7.1.1 Purpose

#### 7.1.2 Contents

<a href="#">7.1 Overview</a>	73
<a href="#">7.2 Purpose</a>	73
<a href="#">7.3 General</a>	73
<a href="#">7.4 Prerequisites</a>	73
<a href="#">7.5 Recommended tools</a>	73
<a href="#">7.6 Safety information</a>	74
<a href="#">7.7 Procedure</a>	74

### 7.2 Purpose

This chapter provides the steps to replace a XS-2426G-B indoor ONT.

### 7.3 General

The steps listed in this chapter describe mounting and cabling for a XS-2426G-B indoor ONT.

### 7.4 Prerequisites

You need the following items before beginning the installation:

- all required cables

### 7.5 Recommended tools

You need the following tools for replacing the ONT:

- #2 Phillips screwdriver
- 1/4 in. (6 mm) flat blade screwdriver
- wire strippers
- fiber optic splicing tools
- RJ-45 cable plug crimp tool
- voltmeter or multimeter
- optical power meter

- drill and drill bits

## 7.6 Safety information

Read the following safety information before replacing the unit.



### DANGER

#### Hazard

*Hazardous electrical voltages and currents can cause serious physical harm or death. Always use insulated tools and follow proper safety precautions when connecting or disconnecting power circuits.*

*Make sure all sources of power are turned off and have no live voltages present on feed lines or terminals. Use a voltmeter to measure for voltage before proceeding.*

*Always contact the local utility company before connecting the enclosure to the utilities.*



### WARNING

#### Equipment Damage

*This equipment is ESD sensitive. Proper ESD protections should be used when removing the fiber access cover of the indoor ONT.*



### CAUTION

#### Service Disruption

*Keep indoor ONTs out of direct sunlight. Prolonged exposure to direct sunlight can damage the unit.*



**Note:** Observe the local and national laws and regulations that may be applicable to this installation.

Observe the following:

- The indoor ONT should be installed in accordance with the applicable requirements of the NEC or CEC. Local authorities and practices take precedent when there is conflict between the local standard and the NEC or CEC.
- The indoor ONT must be installed by qualified service personnel.
- Indoor ONTs must be installed with cables that are suitably rated and listed for indoor use.
- See the detailed specifications in the [Chapter 5, "XS-2426G-B unit data sheet"](#) for the temperature ranges of these ONTs.

## 7.7 Procedure

Use this procedure to replace a XS-2426G-B indoor ONT.

1

Deactivate the ONT services at the P-OLT.

If you are using the SLID feature, this step is not required. The ONT and the services can remain in service (IS).

- a. Use the RTRV-ONT command to verify the ONT status and th associated services. Record the serial number or the SLID of the ONT displayed in the command output.

Example:

```
RTRV-ONT::ONT-1-1-1-1-1;
```

- b. If the ONT is in service, place the ONT in OOS state.

Example:

```
ED-ONT::ONT-1-1-1-1-1;
```

2

If used, disable the Wi-Fi service by pressing the WLAN button; see the following figure for the location of the WLAN button.

Figure 7-1 XS-2426G-B indoor ONT connections

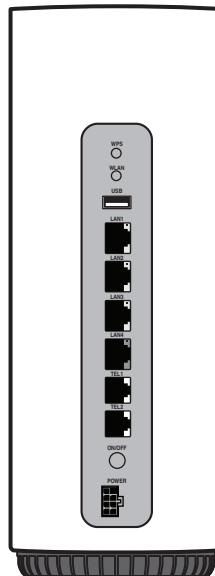

36993

Figure 7-2 XS-2426G-B indoor ONT connections (labelled)

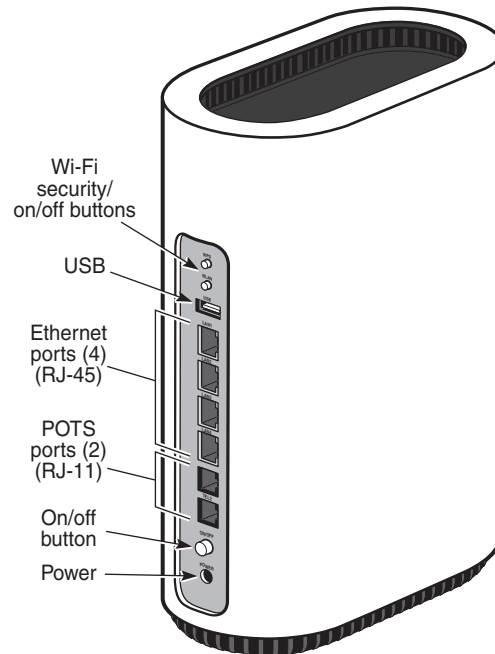

36737

3

Power down the unit by using the on/off power switch.

4

Disconnect the POTS, Ethernet, and power cables from the ONT; see [Figure 7-1, “XS-2426G-B indoor ONT connections” \(p. 75\)](#) for the connector locations on the XS-2426G-B indoor ONT.

5

**DANGER****Hazard**

*Fiber cables transmit invisible laser light. To avoid eye damage or blindness, never look directly into fibers, connectors, or adapters.*

Disconnect the fiber optic cables.

- a. Unplug the fiber optic cable with SC/APC connector from the bottom of the ONT.
- b. Attach a fiber dust cover to the end of the SC/APC connector.

---

6 \_\_\_\_\_  
Replace the old ONT with a new ONT on a flat surface, such as a desk or shelf.

7 \_\_\_\_\_  
Connect the Ethernet cables directly to the RJ-45 ports; see [Figure 7-1, “XS-2426G-B indoor ONT connections” \(p. 75\)](#) for the location of the RJ-45 ports.

8 \_\_\_\_\_  
Connect the POTS cable directly to the RJ-11 port as per local practices; see [Figure 7-1, “XS-2426G-B indoor ONT connections” \(p. 75\)](#) for the location of the RJ-11 ports.

9 \_\_\_\_\_



*Fiber optic cables transmit invisible laser light. To avoid eye damage or blindness, never look directly into fibers, connectors, or adapters.*

If required, have approved service personnel who are trained to work with optic fiber clean the fiber optic connection. See the **Nokia ONT Configuration, Management, and Troubleshooting Guide** for more information about fiber optic handling, inspection, and cleaning.

10 \_\_\_\_\_



*Fiber cables transmit invisible laser light. To avoid eye damage or blindness, never look directly into fibers, connectors, or adapters.*



*Be careful to maintain a bend radius of no less than 1.5 in. (3.8 cm) when connecting the fiber optic cable. Too small of a bend radius in the cable can result in damage to the optic fiber.*

Connect the fiber optic cable with SC/APC adapter into the SC/APC connector on the bottom of the ONT.

**i** **Note:** Fiber cable preparation varies depending on the type and size of the inside or outside plant fiber cable being spliced to the SC/APC fiber optic pigtail cable.

- 
- 11 \_\_\_\_\_  
Connect the power cable to the power connector.
- 12 \_\_\_\_\_  
Power up the unit by using the power switch.
- 13 \_\_\_\_\_  
If used, enable the Wi-Fi service by pressing the WLAN button; see [Figure 7-1, “XS-2426G-B indoor ONT connections” \(p. 75\)](#) for the location of the WLAN button.
- 14 \_\_\_\_\_  
If used, configure the SLID; see the **Nokia ONT Configuration, Management, and Troubleshooting Guide** for more information.
- i** **Note:** A new SLID or the old SLID may be used with the replacement ONT.  
If a new SLID is used, the new SLID must also be programmed at the P-OLT using TL1 or a network manager.  
If the old SLID is used, no changes need to be made at the P-OLT; see the operations and maintenance documentation for the OLT for more details.
- 15 \_\_\_\_\_  
Verify the ONT LEDs, voltage status, and optical signal levels; see the **Nokia ONT Hardware and Cabling Installation Guide**.
- 16 \_\_\_\_\_  
Activate and test the services; see the **Nokia ONT Hardware and Cabling Installation Guide**.
- 17 \_\_\_\_\_  
If necessary, reset the ONT.
- Locate the Reset button on a XS-2426G-B indoor ONT as shown in [Figure 7-1, “XS-2426G-B indoor ONT connections” \(p. 75\)](#).
  - Insert the end of a straightened paper clip or other narrow object into the hole in the Reset button to reset the ONT.
- END OF STEPS \_\_\_\_\_

## 8 Configure a XS-2426G-B indoor ONT

### 8.1 Overview

#### 8.1.1 Purpose

#### 8.1.2 Contents

8.1 Overview	79
<b>GUI configuration</b>	82
8.2 General configuration	82
8.3 HGU mode GUI configuration	82
8.4 Log in to web-based GUI	82
8.5 Viewing overview information	83
<b>Viewing device information and connection status</b>	85
8.6 Overview	85
8.7 Viewing device information	85
8.8 Viewing LAN status	87
8.9 Viewing WAN status	88
8.10 Viewing WAN IPv6 status	89
8.11 Viewing STA information	90
8.12 Viewing Neighboring Access Points	91
8.13 Viewing home networking information	92
8.14 Viewing optics module status	93
8.15 Viewing statistics	94
8.16 Viewing voice information	96
<b>Network configuration</b>	98
8.17 Overview	98
8.18 Configuring LAN	98
8.19 Configuring LAN IPv6	100
8.20 Configuring WAN	101
8.21 Configuring WAN DHCP	103

8.22	Configuring Wireless 2.4GHz	104
8.23	Configuring Wireless 5GHz	106
8.24	Configuring wireless scheduling	108
8.25	Configuring IP routing	109
8.26	Configuring DNS	110
8.27	Configuring TR-069	111
8.28	Configuring GRE tunnel	112
8.29	Configuring Upstream (US) Classifier	113
8.30	Configuring QoS	117
	<b>Security configuration</b>	120
8.31	Overview	120
8.32	Configuring the firewall	120
8.33	Configuring the MAC filter	121
8.34	Configuring the IP filter	122
8.35	Configuring the URL filter	123
8.36	Configuring DMZ and ALG	124
8.37	Configuring access control	125
	<b>Configuring the Application</b>	127
8.38	Overview	127
8.39	Configuring port forwarding	127
8.40	Configuring port triggering	128
8.41	Configuring DDNS	129
8.42	Configuring NTP	130
8.43	Configuring USB	131
8.44	Configuring UPnP and DLNA	132
	<b>Maintenance</b>	133
8.45	Overview	133
8.46	Configuring the password	133
8.47	Configuring LOID	134
8.48	Configuring SLID	135
8.49	Managing the device	136



8.50 Backing up the configuration	137
8.51 Restoring the configuration	138
8.52 Upgrading firmware	139
8.53 Rebooting the device	139
8.54 Resetting to factory defaults	140
8.55 Diagnosing WAN connections	141
8.56 Viewing log files	142
<b>RG Troubleshooting Counters</b>	144
8.57 Overview	144
8.58 Viewing Residential Gateway (RG) troubleshooting counters	144

---

## GUI configuration

### 8.2 General configuration

Refer to the configuration information provided with your OLT for the software configuration procedure for a XS-2426G-B ONT.

For HTTP configuration procedures, refer to the **Nokia ONT Configuration, Management, and Troubleshooting Guide**.

### 8.3 HGU mode GUI configuration

Use the procedures below to use the web-based GUI for the XS-2426G-B in HGU mode. This mode is preset at delivery.

A home gateway unit (HGU) is a home networking device, used as a gateway to connect devices in the home through fiber to the Internet. An HGU provides a variety of features for the home network including routing and firewall capability. By using the HGU, users can connect all smart equipment in their home, including personal computers, set-top boxes, mobile phones, and other consumer electronics devices, to the Internet.

The XS-2426G-B ONTs support TLSv1.2 for WEBGUI (HTTPS).

### 8.4 Log in to web-based GUI

1

---

Open a web browser and enter the IP address of the ONT in the address bar.

The login page displays.

The default gateway IP address must be same as the one printed on the device label. You can connect to this IP address using your web browser after connecting your PC to one of Ethernet ports of the ONT. The static IP address of your PC must be in the same default gateway subnet as the ONT.

2



#### CAUTION

##### Service Disruption

*Pressing the **Reset** button for less than 10 seconds reboots the ONT; pressing the **Reset** button for 10 seconds resets the ONT to the factory defaults, except for the LOID and SLID.*

Enter your username and password in the Login page, as shown in [Figure 8-1, “Web login page” \(p. 83\)](#).

The default end-user account name and the default password for this account are printed on the device label. The superadmin account is meant for the Operator and is unique per device. Contact your Nokia representative to obtain the superadmin password based on the serial number on the device.

Figure 8-1 Web login page



**i** **Note:** If you forget the current username and password, press the reset button for 5 seconds and the default values for the username and password will be recovered at startup.

3

Click **Login**. The Device Information page displays.

**i** **Note:** To help protect the security of your Internet connection, the application displays a pop-up reminder to change both the Wi-Fi password and the ONT password. To increase password security, use a minimum of 10 characters, consisting of a mix of numbers and upper and lower case letters.

END OF STEPS

## 8.5 Viewing overview information

1

Click **Overview** from the left pane. The Overview page displays.

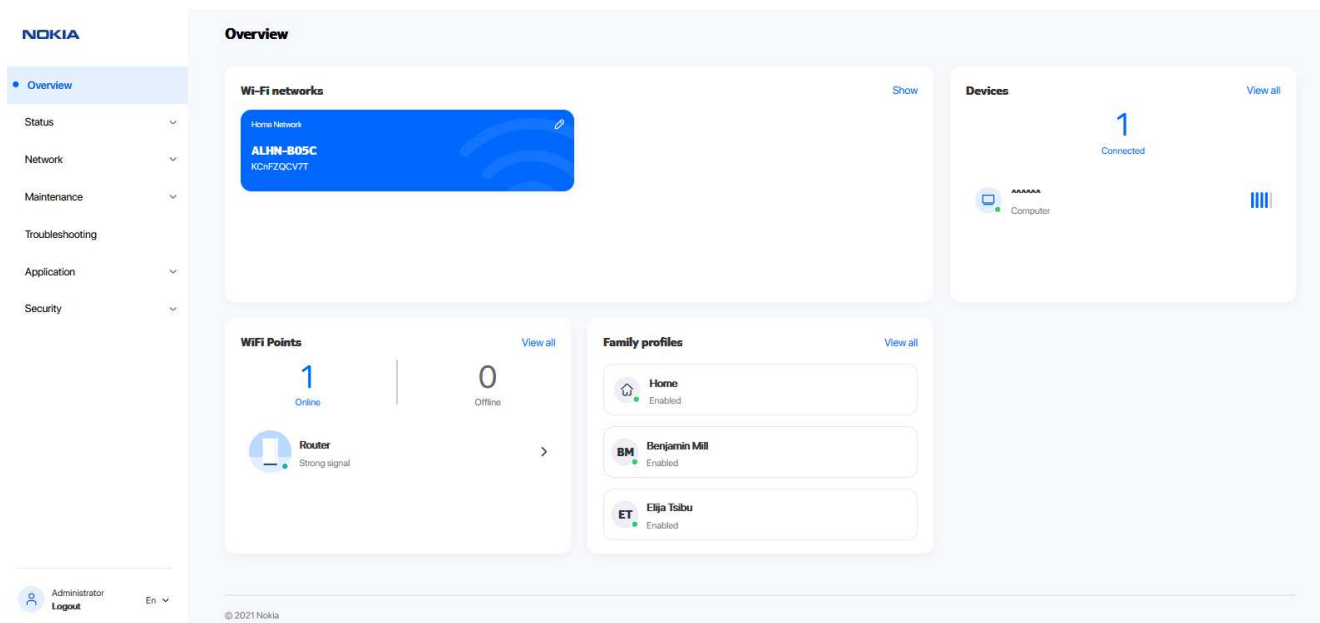

Table 8-1 Overview parameters

Field	Description
<b>Overview Information</b>	
<b>WiFi-Networks</b>	
Home Network	Name of the IP WAN connection of the Nokia WiFi beacon. You can edit the name.
Wi-Fi points	Indicates the number of active routers.
<b>Family Profile</b>	
Displays the profile of the members connected to the network topology	
<b>Devices</b>	
Displays the type of device connected.	

2

Check that you are connected to the Internet, as shown in "Purpose" (p. 0).

END OF STEPS

## Viewing device information and connection status

### 8.6 Overview

#### 8.6.1 Purpose

This chapter describes procedures to view device information and connection status on the XS-2426G-B.

#### 8.6.2 Contents

8.6 Overview	85
8.7 Viewing device information	85
8.8 Viewing LAN status	87
8.9 Viewing WAN status	88
8.10 Viewing WAN IPv6 status	89
8.11 Viewing STA information	90
8.12 Viewing Neighboring Access Points	91
8.13 Viewing home networking information	92
8.14 Viewing optics module status	93
8.15 Viewing statistics	94
8.16 Viewing voice information	96

### 8.7 Viewing device information

1

Click **Status**→**Device Information** from the left pane. The Device Information page displays the following information about the device.

Figure 8-2 Device Information page

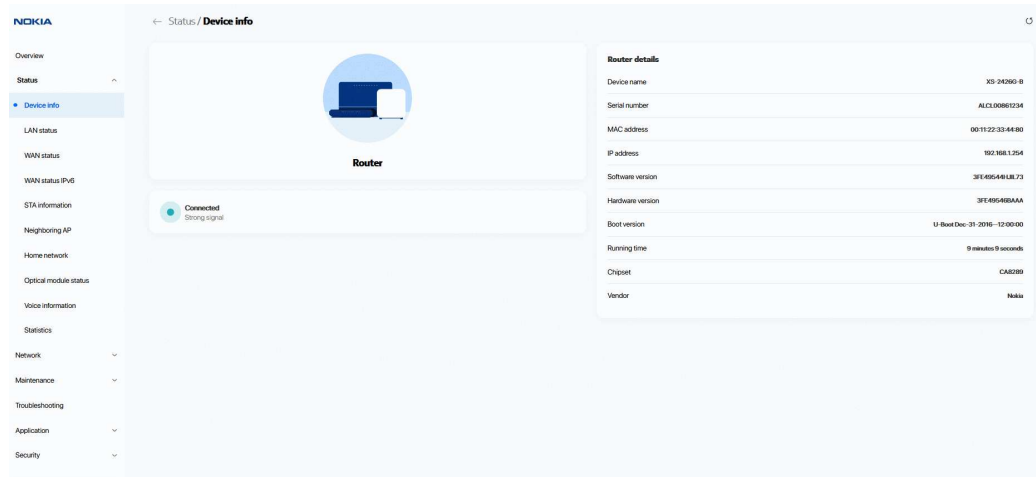

**i** **Note:** Upon login, the Home Gateway page displays the WAN status block on the bottom left part of each page. This block shows the WAN connection ID, the WAN status, and any WAN errors.

This block is accurate upon login, but it is static.

Table 8-2 Device Information parameters

Field	Description
Device Name	Name on the ONT
Serial Number	Serial number of the ONT
MAC address	MAC address
IP address	IP address
Software version	Software version of the ONT
Hardware version	Hardware version of the ONT
Boot version	Boot version of the ONT
Running Time	Amount of time the device has run since last reset in hours, minutes, and seconds
Chipset	Chipset of the ONT
Vendor	Name of the vendor

You can click  to update the displayed information.

END OF STEPS

## 8.8 Viewing LAN status

1

Click **Status**→**LAN Status** from the left pane. The LAN Status page displays the following information.

Figure 8-3 LAN Status page



Table 8-3 LAN Status parameters

Field	Description
<b>LAN Wireless Information</b>	
Wireless status	Indicates whether the wireless is on or off
Wireless channel	Wireless channel number
Wireless encryption status	Encryption type used on the wireless connection
Wireless Rx packets	Number of packets received on the wireless connection
Wireless Tx packets	Number of packets transmitted on the wireless connection
Wireless Rx bytes	Number of bytes received on the wireless connection
Wireless Tx bytes	Number of bytes transmitted on the wireless connection
Power transmission (mW)	Power of the wireless transmission, in mW
<b>LAN ethernet info</b>	
Ethernet status	Indicates whether the Ethernet connection is on or off
Ethernet IP address	IP address of the Ethernet connection
Ethernet subnet mask	Subnet Mask of the Ethernet connection
Ethernet MAC address	MAC address of the Ethernet connection

Table 8-3 LAN Status parameters (continued)

Field	Description
Ethernet Rx packets	Number of packets received on the Ethernet connection
Ethernet Tx packets	Number of packets transmitted on the Ethernet connection
Ethernet Rx bytes	Number of bytes received on the Ethernet connection
Ethernet Tx bytes	Number of bytes transmitted on the Ethernet connection

You can click  to update the displayed information.

END OF STEPS

## 8.9 Viewing WAN status

1

Click **Status**→**WAN Status** from the left pane. The WAN Status page displays the following information.

Figure 8-4 WAN Status page

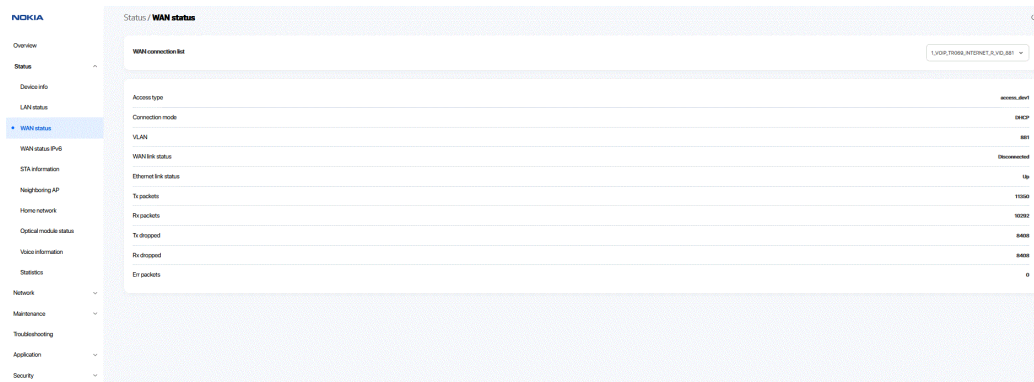

Table 8-4 WAN Status parameters

Field	Description
WAN Connection List	Drop-down menu listing all WAN connections. The connection shown is the connection for which WAN status will be shown.
Access type	Indicates the access type
Connection mode	Connection mode of the WAN connection
VLAN	VLAN ID
WAN link status	Indicates whether the WAN link is up or down



Table 8-4 WAN Status parameters (continued)

Field	Description
Ethernet link status	Indicates whether the Ethernet link is up or down
Tx packets	Number of packets transmitted on the WAN connection
Rx packets	Number of packets received on the WAN connection
Tx dropped	Number of packets dropped on the transmit WAN connection
Rx dropped	Number of packets dropped on the receive WAN connection
Err packets	Number of errored packets on the WAN connection

You can click  to update the displayed information.

END OF STEPS

## 8.10 Viewing WAN IPv6 status

1

Click **Status**→**WAN Status IPv6** from the left pane. The WAN Status IPv6 page displays the following information.

Figure 8-5 WAN Status IPv6 page



Table 8-5 WAN Status IPv6 parameters

Field	Description
Access type	Indicates the access type.

Table 8-5 WAN Status IPv6 parameters (continued)

Field	Description
Connection mode	Indicates the mode of connection.
VLAN	VLAN ID
WAN Connection List	Drop-down menu listing all WAN connections. The connection shown is the connection for which WAN status will be shown.
Enable/Disable	Select this checkbox to enable the WAN connection
WAN Link Status	Whether the WAN link is up or down
IP Address (v6)	IPv6 address that identifies the device and its location
IPv6 Address Prefix	IPv6 prefix
Gateway (IPv6 )	IPv6 gateway address
Primary DNS (v6)	Primary Domain Name Server
Ethernet Link Status	Whether the Ethernet link is up or down
Tx Packets	Number of packets transmitted on the WAN connection
Rx Packets	Number of packets received on the WAN connection
Tx Dropped	Number of packets dropped on the transmit WAN connection
Rx Dropped	Number of packets dropped on the receive WAN connection
Err Packets	Number of errored packets on the WAN connection

You can click  to update the displayed information.

END OF STEPS

## 8.11 Viewing STA information

1

Click **Status**→**STA Information** from the left pane. The STA Information page displays the following information.

Figure 8-6 STA Information page

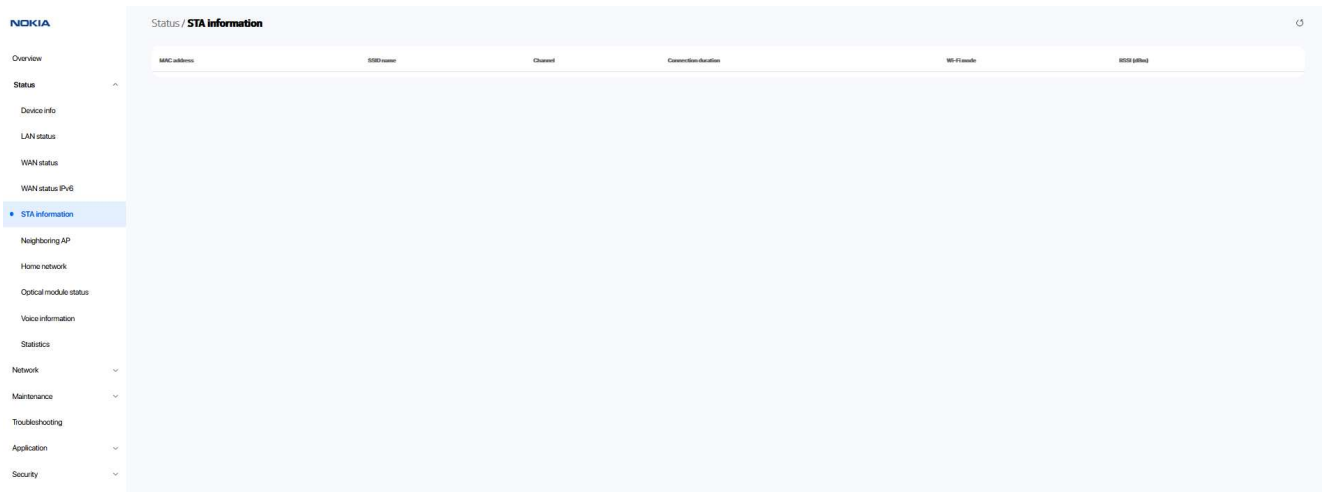

Table 8-6 STA information parameters

Field	Description
MAC Address	MAC address of the Ethernet connection
SSID Name	Name of each SSID
Channel	Indicates the channel number
Connection Duration	Indicates the connection duration
Wi-Fi Mode	Indicates the Wi-Fi mode
RSSI (dBm)	Indicates the received signal strength

You can click  to update the displayed information.

END OF STEPS

## 8.12 Viewing Neighboring Access Points

1

Click **Status**→**Neighboring AP** from the left pane. The Neighboring Access Points page displays the following information.

Figure 8-7 Neighboring AP page

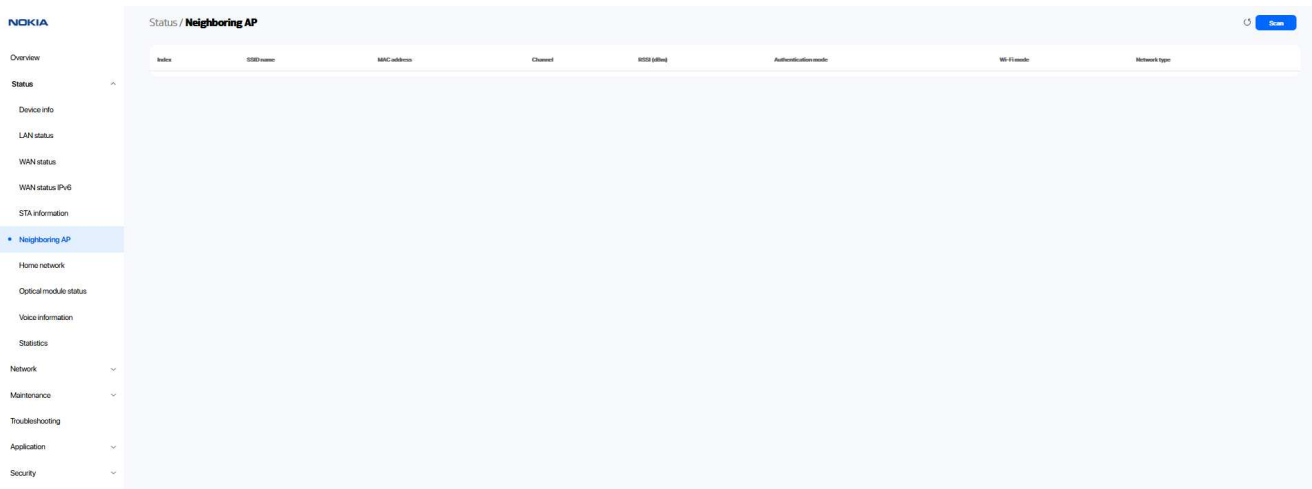

Table 8-7 Neighboring AP parameters

Field	Description
Index	Name of the index
SSID name	Name of each SSID
MAC address	MAC address of the Ethernet connection
Channel	Indicates the channel number
RSSI (dBm)	Indicates the received signal strength
Authentication Mode	Indicates the authentication mode
Wi-Fi Mode	Indicates the Wi-Fi mode
Network Type	Indicates the network type

2

Click **Scan**.

END OF STEPS

## 8.13 Viewing home networking information

1

Click **Status**→**Home Networking** from the left pane. The Home Networking page displays the following information.

Figure 8-8 Home Networking page

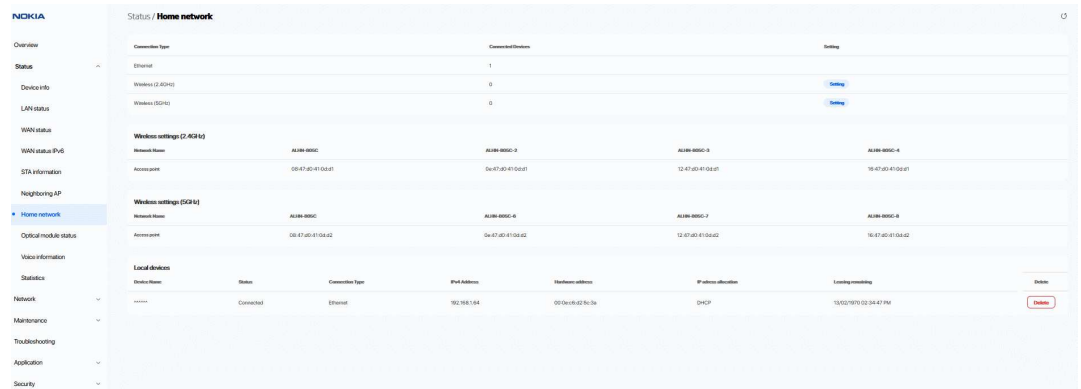



Table 8-8 Home Networking parameters

Field	Description
<b>Local Interface</b>	
Ethernet	Table displays the number of Ethernet connections and their settings
Wireless	Table displays the number of wireless connections and their settings (2.4GHz and 5GHz)
<b>Wireless Settings (2.4GHz and 5GHz)</b>	
Network Name	Name of the wireless network
Access Point	Hexadecimal address of the wireless access point
<b>Local Devices</b>	
Table entry	Each entry indicates the status (active or inactive), connection type, device name, IP address, hardware address, IP address allocation, lease remaining, and last active time of each connected local device.

You can:

- Click **Delete** to delete a particular local device connection.
- You can click  to update the displayed information.

END OF STEPS

## 8.14 Viewing optics module status

1

Click **Status**→**Optics Module Status** from the left pane. The Optics Module Status page displays the following information.

Figure 8-9 Optics Module Status page

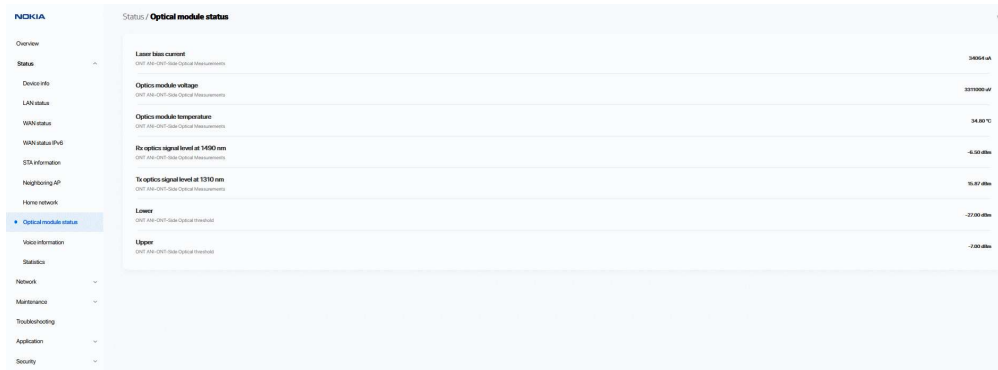

Table 8-9 Optics Module Status parameters

Field	Description
Laser Bias Current (ONT ANI-ONT-Side Optical Measurements)	Laser bias current, measured in uA
Optics Module Voltage (ONT ANI-ONT-Side Optical Measurements)	Optics module voltage, measured in V
Optics Module Temperature (ONT ANI-ONT-Side Optical Measurements)	Optics module temperature, measured in C
Rx Optics Signal Level at 1490 nm (ONT ANI-ONT-Side Optical Measurements)	Received optics signal level at 1577 nm, measured in dBm
Tx Optics Signal Level at 1310 nm (ONT ANI-ONT-Side Optical Measurements)	Transmitted optics signal level at 1270 nm, measured in dBm
Lower (ONT ANI-ONT-Side Optical Measurements-Optical Threshold)	Lower optical threshold, measured in dBm
Upper (ONT ANI-ONT-Side Optical Measurements-Optical Threshold)	Upper optical threshold, measured in dBm

You can click  to update the displayed information.

END OF STEPS

## 8.15 Viewing statistics

1

Click **Status**→**Statistics** from the left pane.

Select the **LAN** tab, **WAN** tab or **WLAN** tab to view the respective ports.

Figure 8-10 LAN Statistics page

Category	LAN	LAN2	LAN3	LAN4
Bytes sent	450979	450792	312708	0
Bytes received	2048	0	483229	0
Packets sent	3470	3466	3221	0
Packets received	32	0	2668	0
Errors sent	0	0	0	0
Unicast packets sent	1278	1278	2604	0
Unicast packets received	0	0	1089	0
Discard packets sent	0	0	0	0
Discard packets received	0	0	0	0
Multicast packets sent	1922	1922	714	0
Multicast packets received	32	0	1432	0
Broadcast packets sent	199	199	3	0
Broadcast packets received	0	0	146	0
Unknown-protocol packets received	0	0	0	0
CRC errors received	0	0	0	0

Figure 8-11 WAN Statistics page

Category	1, WAN (WAN1, WAN2 & WAN3)	2, OTHERS (LAN, WLAN)	3, OTHERS (LAN, WLAN)
Bytes sent	1629398	1639398	1639398
Bytes received	1629394	1629394	1629394
Packets sent	12905	12905	12905
Packets received	11820	11820	11820
Errors sent	0	0	0
Errors received	0	0	0
Unicast packets sent	0	0	0
Unicast packets received	0	0	0
Discard packets sent	8405	8405	8405
Discard packets received	8405	8405	8405
Broadcast packets sent	0	0	0
Broadcast packets received	0	0	0
Unknown-protocol packets received	0	0	0
Rx drops	8405	8405	8405
Tx drops	8405	8405	8405
Failures	0	0	0
Timeouts	0	0	0

Figure 8-12 WLAN Statistics page

Category	1, WLAN (WLAN1, WLAN2)	2, OTHERS (LAN, WLAN)
Bytes sent	0	0
Bytes received	0	0
Packets sent	0	0
Packets received	0	0
Errors sent	0	0
Errors received	0	0
Unicast packets sent	0	0
Unicast packets received	0	0
Rx drops	0	0
Tx drops	0	0

You can click  to update the displayed information.

END OF STEPS

## 8.16 Viewing voice information

1

Click **Status**→**Voice Information** from the left pane. The Voice Information page displays the following information:

Figure 8-13 Voice Information page



Table 8-10 Voice Information parameters

Field	Description
POTS 1 registration status	Indicates if POTS 1 is registered or not. The default is Registered Blank if no voice service is provisioned
POTS2 registration status	Indicates if POTS 2 is registered or not. The default is Registered Blank if no voice service is provisioned
POTS 1 line state	Indicates the line in POTS 1. The default is Disabled.
POTS 2 line state	Indicates the line in POTS 2. The default is Disabled.
Softswitch line1	Proxy IP address; blank if the line is not registered
Softswitch line 2	Proxy IP address; blank if the line is not registered
Telephone line1 phone number	Phone number configured for a telephone line 1; +13290611266
Telephone line 2 phone number	Phone number configured for a telephone line 2



Table 8-10 Voice Information parameters (continued)

Field	Description
Line 1 registration error code	SIP standard error code for the register status; for example, 401, 403, 503 This field is blank if the register is set to OK
Line 2 registration error code	SIP standard error code for the register status;
Line 2 registration error reason	SIP standard error reason for the register status This field is blank if the register is set to OK
User agent IP	IP address of the user agent ExternalIPAddress in WANIPConnection or WANPPPConnection

You can click  to update the displayed information.

END OF STEPS

## Network configuration

### 8.17 Overview

#### 8.17.1 Purpose

This chapter describes the network configuration tasks supported by XS-2426G-B ONTs.

#### 8.17.2 Contents

8.17 Overview	98
8.18 Configuring LAN	98
8.19 Configuring LAN IPv6	100
8.20 Configuring WAN	101
8.21 Configuring WAN DHCP	103
8.22 Configuring Wireless 2.4GHz	104
8.23 Configuring Wireless 5GHz	106
8.24 Configuring wireless scheduling	108
8.25 Configuring IP routing	109
8.26 Configuring DNS	110
8.27 Configuring TR-069	111
8.28 Configuring GRE tunnel	112
8.29 Configuring Upstream (US) Classifier	113
8.30 Configuring QoS	117

### 8.18 Configuring LAN

1

Click **Network**→**LAN** from the left pane. The LAN page displays.

Figure 8-14 LAN page

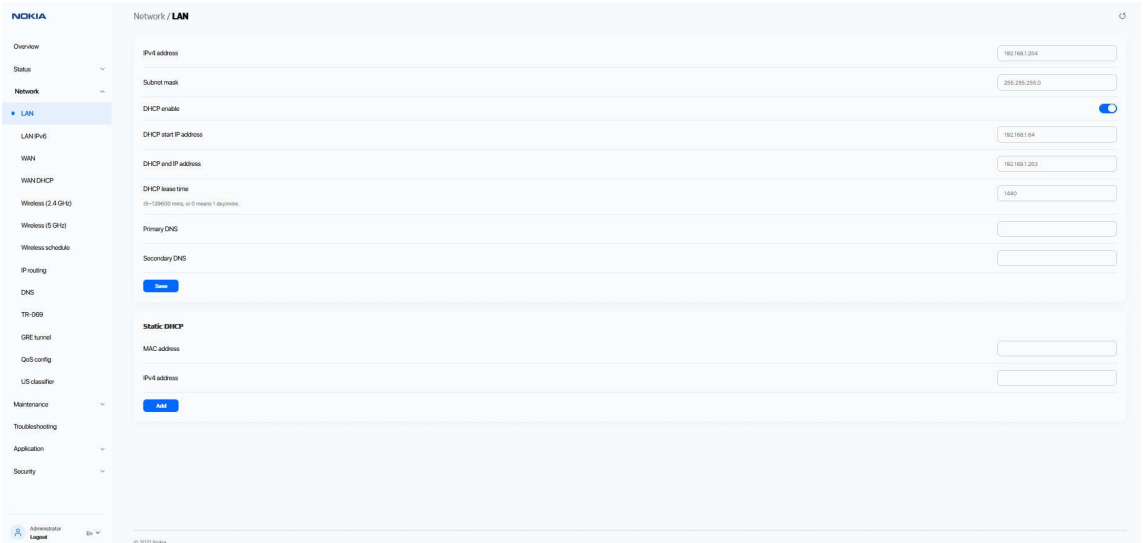

2

Configure the following LAN parameters:

Table 8-11 LAN parameters

Field	Description
<b>Port Mode</b>	
IPv4 address	Enter the IPv4 address of the ONT.
Subnet Mask	Enter the subnet mask of the ONT.
DHCP enable	Select this checkbox to enable DHCP.
DHCP start IP address	Enter the starting DHCP IP address.
DHCP end IP address	Enter the ending DHCP IP address.
DHCP lease time	Enter the DHCP lease time (in min).
Primary DNS	Enter the primary DNS identifier.
Secondary DNS	Enter the secondary DNS identifier.
<b>Static DHCP Entry</b>	
MAC Address	Enter the MAC address of the static DHCP
IPv4 Address	Enter the IPv4 address for the static DHCP

3

Click **Save**.

4 \_\_\_\_\_  
Configure the Static DHCP parameters.

5 \_\_\_\_\_  
Click **Add**.  
You can click **Delete** to delete a Static DHCP MAC address or IPv4 address.

END OF STEPS \_\_\_\_\_

## 8.19 Configuring LAN IPv6

1 \_\_\_\_\_  
Click **Network**→**LAN\_IPv6** from the left pane. The LAN\_IPv6 page displays.

Figure 8-15 LAN IPv6 page

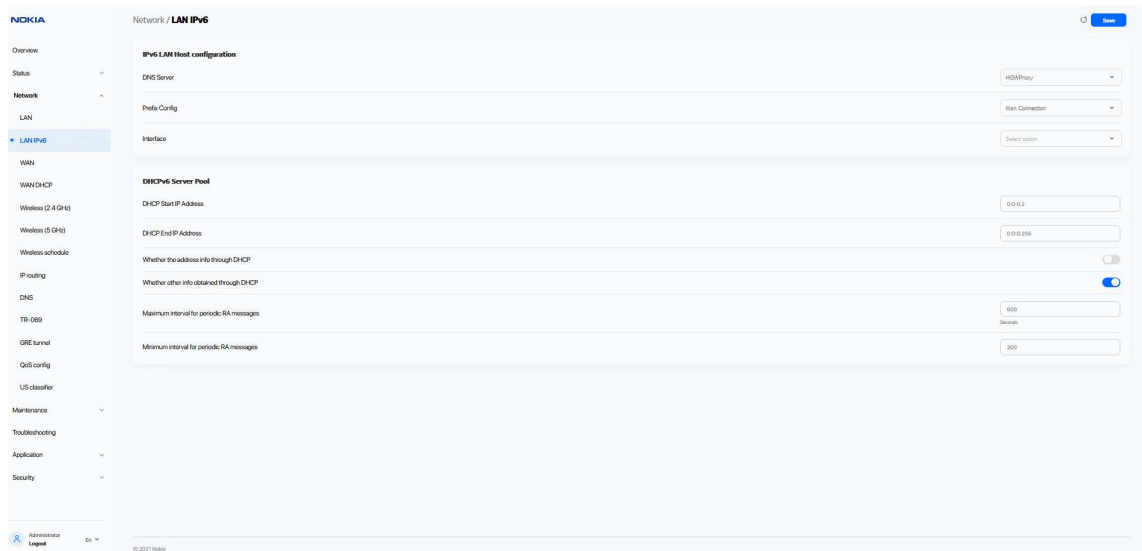

2 \_\_\_\_\_  
Configure the following parameters:

Table 8-12 LAN IPv6 parameters

Field	Description
<b>IPv6 LAN Host Configuration</b>	
DNS Server	Select a DNS server from the list.

Table 8-12 LAN IPv6 parameters (continued)

Field	Description
Prefix Config	Select a prefix config option from the list: <ul style="list-style-type: none"> <li>• <b>WANConnection</b> (prefix will be obtained from the WAN), or</li> <li>• <b>Static</b> (enables you to enter the prefix)</li> </ul>
Interface	This field displays if you select the <b>WanConnection</b> option from the Prefix Config field. Select a WAN connection interface from the list.
<b>DHCPv6 Server Pool</b>	
DHCP Start IP Address	Enter the starting DHCP IP address.
DHCP End IP Address	Enter the ending DHCP IP address.
Whether the address info through DCHP	Select this checkbox to enable address information retrieval through DHCP.
Whether other info obtained through DHCP	Select this checkbox to enable retrieval of other information through DHCP.
Maximum interval for periodic RA messages	Enter the maximum interval (in seconds) for periodic Router Advertisement messages. The interval range is from 4 to 1800.
Minimum interval for periodic RA messages	Enter the minimum interval (in seconds) for periodic Router Advertisement messages. The interval range is from 4 to 1800.

3

Click **Save/Apply**.

END OF STEPS

## 8.20 Configuring WAN

1

Click **Network**→**WAN** from the left pane. The WAN page displays.

Figure 8-16 WAN page

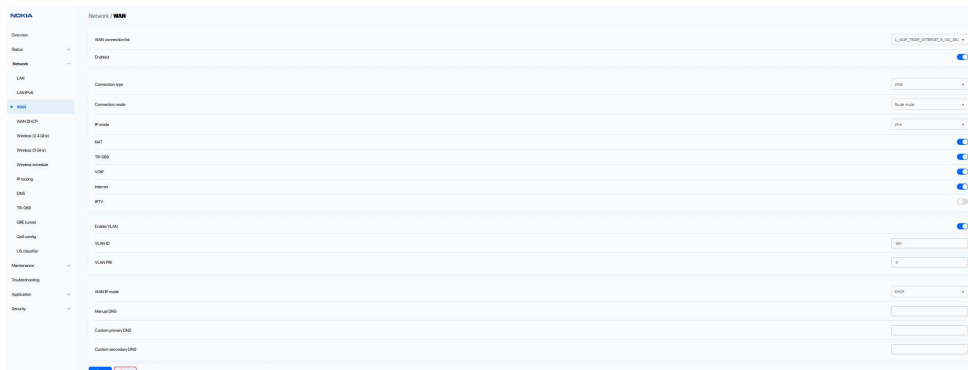

## 2

Configure the following parameters:

Table 8-13 WAN parameters

Field	Description
WAN connection list	Select a WAN connection from the list to set the connection parameters.
Enabled	Tap the Enable / Disable toggle to enable or disable the WAN connection.
Connection type	Select a connection type: IPoE or PPPoE.
Connection mode	Select the connection mode of the WAN connection: <ul style="list-style-type: none"> <li>• Route mode</li> <li>• Bridge mode</li> </ul>
IP mode	Select an IP mode from the list: IPv4 or IPv6.
Enable	Click to enable the WAN connection.
NAT	Select this checkbox to enable NAT.
Service	Enable/disable the following service types for this connection as required. <ul style="list-style-type: none"> <li>• VOIP</li> <li>• TR-069</li> <li>• INTERNET</li> <li>• IPTV</li> </ul>
Enable VLAN	Tap the Enable/disable toggle enable VLAN.
VLAN ID	Enter the VLAN ID.
VLAN PRI	Enter the VLAN PRI.
WAN IP Mode	Select an IP mode from the list.
Manual DNS	Enter the Domain Name Server (DNS) to be configured manually.
Custom primary DNS	Enter the primary Domain Name Server (DNS).
Custom secondary DNS	Enter the secondary Domain Name Server (DNS).
Connection Type: <b>PPPoE</b>	
Connection trigger	Select the connection trigger type from the drop down list. The default option is <b>Always On</b> .
Username	Enter the username to login to the configuration server.
Password <sup>1</sup>	Enter the password to login to the configuration server.
Keep Alive Time	The PPPoE connection type triggers one heartbeat each, between 5 to 60 seconds to keep the session online. Enter the value between 5 to 60 seconds depending on the configuration type.
Keep Alive Retry	The PPPoE connection type sends out several heartbeats as retry time between 1 to 10 times. Enter the value between 1 to 10 times as required.

Table 8-13 WAN parameters (continued)

Field	Description
Echo Value	Indicates the number of times, the device sent messages to the server to check if the IP address is available or not.

**Notes:**

1. Allowed characters are limited to numbers, letters and special characters ! # + , - . / : = @ \_

3

Click **Save**.

END OF STEPS

## 8.21 Configuring WAN DHCP

1

Click **Network** → **WAN DHCP** from the left pane. The WAN DHCP page displays.

Figure 8-17 WAN DHCP page

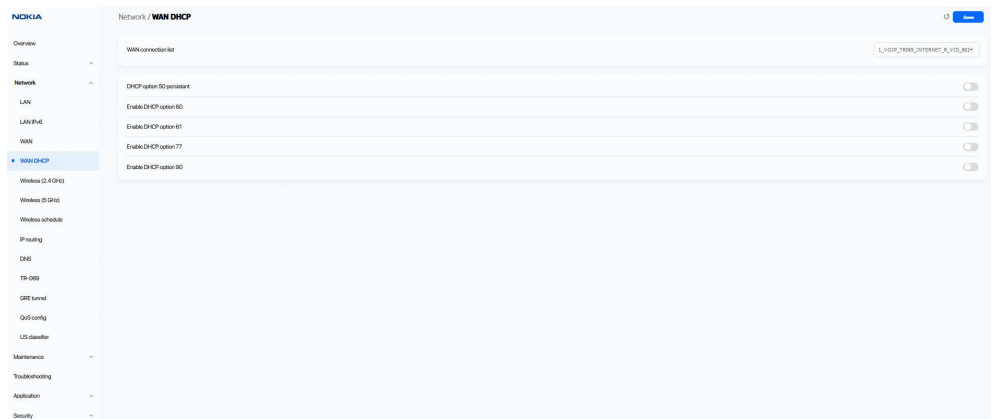

2

Configure the following parameters:

Table 8-14 WAN DHCP parameters

Field	Description
WAN Connection List	Select a WAN connection from the list.
DHCP Option 50 Persistent	Click to enable DHCP Option 50 persistent.

Table 8-14 WAN DHCP parameters (continued)

Field	Description
Enable DHCP Option 60	Click to enable DHCP Option 60 (vendor class identifier).
Enable DHCP Option 61	Click to enable DHCP Option 61 (client identifier).
Enable DHCP Option 77	Click to enable DHCP Option 77 (user class information).
Enable DHCP Option 90	Click to enable DHCP Option 90 (authentication information).

3

Click **Save**.

You can click  to update the displayed information.

END OF STEPS

## 8.22 Configuring Wireless 2.4GHz

1

Click **Network**→**Wireless (2.4GHz)** from the left pane. The Wireless (2.4GHz) page displays.

Figure 8-18 Wireless (2.4GHz) page



2

Configure the following parameters:



Table 8-15 Wireless (2.4GHz) parameters

Field	Description
Enable	Click to enable Wi-Fi.
Mode	Select a Wi-Fi mode from the list: <ul style="list-style-type: none"> <li>• <b>auto (b/g/n/ac/ax)</b></li> <li>• <b>b/g/n</b></li> <li>• <b>b</b></li> <li>• <b>g</b></li> <li>• <b>n</b></li> <li>• <b>b/g</b></li> <li>• <b>g/n</b></li> </ul>
Bandwidth	Select the bandwidth range from the list: <ul style="list-style-type: none"> <li>• <b>20 MHz</b></li> <li>• <b>40 MHz</b></li> <li>• <b>20/40 MHz</b></li> </ul>
Channel	Select a channel from the list or select <b>Auto</b> to have the channel automatically assigned.
Transmitting Power	Select a percentage for the transmitting power from the list: <ul style="list-style-type: none"> <li>• <b>Low (25%)</b></li> <li>• <b>Medium (50%)</b></li> <li>• <b>High (75%)</b></li> <li>• <b>Maximum (100%)</b></li> </ul>
WMM	Select <b>Enable</b> or <b>Disable</b> from the list to enable or disable WiFi multimedia.
Total MAX Users	Enter the number of total MAX users.
<b>SSID Configuration</b>	
SSID Select	Select the SSID from the list.
SSID Name	Enter the SSID name.
Enable SSID	Click to enable or disable the SSID.
SSID Broadcast	Click to enable SSID broadcast.
MAX users	Enter the number of MAX users.
Encryption Mode	Select an encryption mode from the list: <ul style="list-style-type: none"> <li>• <b>WPA/WPA2 Personal</b></li> <li>• <b>WPA3 Personal</b></li> <li>• <b>WPA2/WPA3 Personal</b></li> <li>• <b>WPA/WPA2 Enterprise</b></li> <li>• <b>WEP</b></li> <li>• <b>OPEN</b></li> </ul>

Table 8-15 Wireless (2.4GHz) parameters (continued)

Field	Description
WPA version	Select a WPA version from the list: <ul style="list-style-type: none"> <li>• WPA2</li> <li>• WPA/WPA2</li> </ul>
WPA Encryption Mode	Select a WPA encryption mode from the list: <ul style="list-style-type: none"> <li>• TKIP</li> <li>• AES</li> <li>• TKIP/AES</li> </ul>
Wi-Fi Key	Enter the Wi-Fi key.
Enable WPS	Click to enable or disable WPS from this list.
Domain Grouping	Click to enable domain grouping

3

Click **Save**.You can click  to update the displayed information.

END OF STEPS

## 8.23 Configuring Wireless 5GHz

1

Click **Network**→**Wireless (5GHz)** from the left pane. The Wireless (5GHz) page displays.

Figure 8-19 Wireless (5GHz) page



2

Configure the following parameters:

Table 8-16 Wireless (5GHz) parameters

Field	Description
Enable	Click to enable Wi-Fi.
Bandwidth	Select the bandwidth range from the list: <ul style="list-style-type: none"> <li>• 20 MHz</li> <li>• 40 MHz</li> <li>• 80 MHz</li> </ul>
Channel	Select a channel from the list or select <b>Auto</b> to have the channel automatically assigned.
Transmitting power	Select a percentage for the transmitting power from the list: <ul style="list-style-type: none"> <li>• Low (25%)</li> <li>• Medium (50%)</li> <li>• High (75%)</li> <li>• Maximum (100%)</li> </ul>
WMM	Select <b>Enable</b> or <b>Disable</b> from the list to enable or disable WiFi multimedia.
Enable MU-MIMO	Click to enable or disable MU-MIMO.
Total MAX Users	Enter the total number of MAX users.
DFS Re-entry	Click to enable DFS Re-entry.
<b>SSID Configuration</b>	
SSID Select	Select the SSID from the list.
SSID Name	Enter the SSID name
Enable SSID	Select <b>Enable</b> or <b>Disable</b> from this list.
SSID Broadcast	Select <b>Enable</b> or <b>Disable</b> SSID broadcast from this list.
Port Mode	Select a port mode from the list. The default value is Route.
Isolation	Select <b>Enable</b> or <b>Disable</b> from the list to enable or disable Isolation.
MAX Users	Enter the number of MAX users.
Encryption Mode	Select an encryption mode from the list: <ul style="list-style-type: none"> <li>• None</li> <li>• OPEN</li> <li>• WPA2-AES</li> <li>• WPA2+WPA</li> <li>• WPA3-AES</li> <li>• WPA2+WPA3-AES</li> <li>• WPA</li> <li>• WPA2-Enterprise</li> </ul>

Table 8-16 Wireless (5GHz) parameters (continued)

Field	Description
WPA Key	Enter the WPA key.
Enable WPS	Click to enable or disable WPS.
Domain Grouping	Click to enable domain grouping

3

Click **Save**.

You can click  to update the displayed information.

END OF STEPS

## 8.24 Configuring wireless scheduling

1

Click **Network**→**Wireless schedule** from the left pane. The Wireless schedule page displays.

Figure 8-20 Wireless Schedule page

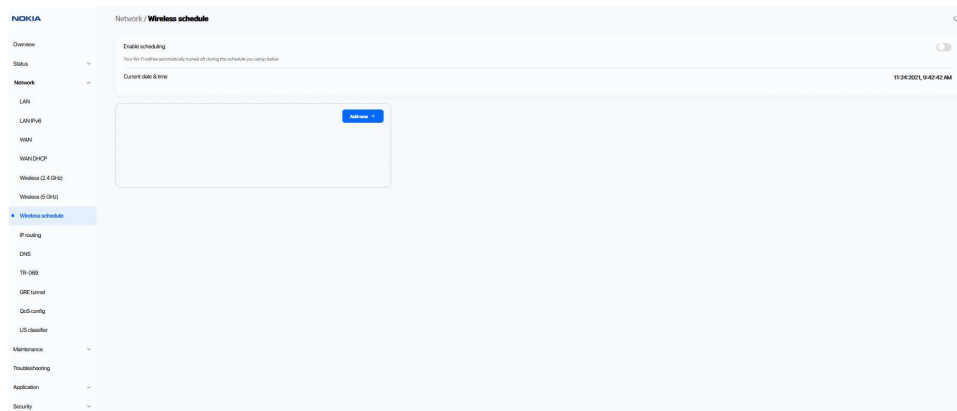

2

Click **Enable Scheduling** to turn the wireless signal off for the configured period.

 **Note:** The ONT stores the settings of the current wireless signal and restores with the same settings when Wi-Fi is enabled or disabled until the programmed wireless signal rule is triggered. The stored value is restored if the active wireless signal schedule rule is

3

Click the plus sign (+) to add a scheduling rule.

A separate panel displays for configuring wireless schedule rules.

4 \_\_\_\_\_

Enter a start time and end time for the period in which you want the wireless signal off.

5 \_\_\_\_\_

Select **Everyday** or **Individual Days** from the list.

6 \_\_\_\_\_

If you select **Individual Days**, select the checkboxes for the desired days.

The Recurrence Pattern shows the rules created to date.

7 \_\_\_\_\_

If desired, click the plus sign (+) to add more rules.

8 \_\_\_\_\_

Click **Save Changes**.

END OF STEPS \_\_\_\_\_

## 8.25 Configuring IP routing

1 \_\_\_\_\_

Click **Network**→**IP Routing** from the left pane. The IP Routing page displays.

Figure 8-21 IP Routing page

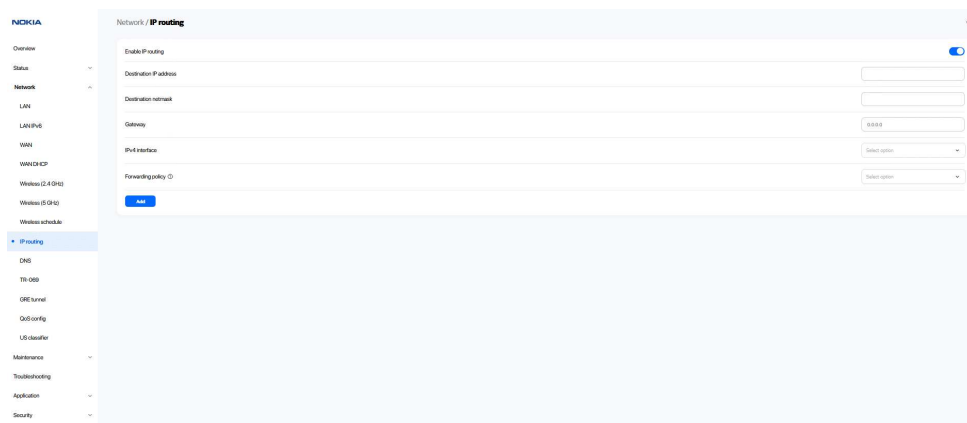

2 \_\_\_\_\_

Configure the following parameters:

Table 8-17 IP Routing parameters

Field	Description
Enable IP routing	Click to enable routing.
Destination IP address	Enter the destination IP address.
Destination netmask	Enter the destination network mask.
Gateway	Enter the gateway address.
IPv4 interface	Select a WAN connection previously created in the WAN network page from the list.
Forwarding Policy	Select a forwarding policy from the list.

3

Click **Add**.

You can click  to update the displayed information.

END OF STEPS

## 8.26 Configuring DNS

1

Click **Network**→**DNS** from the left pane. The DNS page displays.

Figure 8-22 DNS page

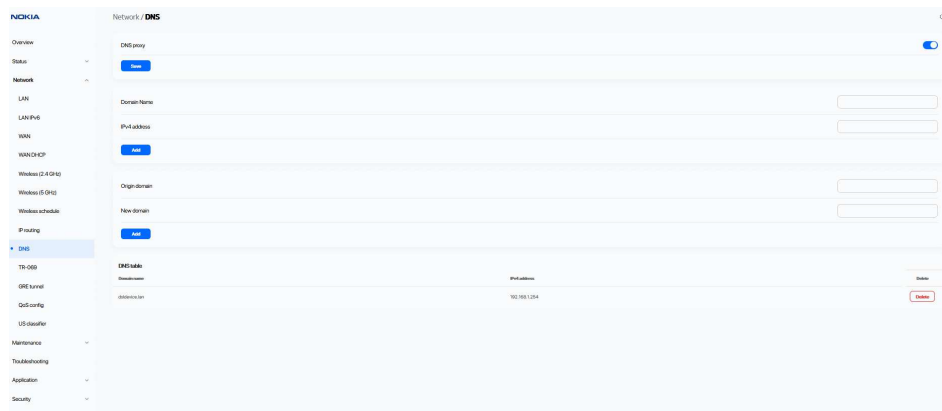

2

Configure the following parameters:

Table 8-18 DNS parameters

Field	Description
DNS Proxy	Click to enable or disable DNS proxy and click <b>Save</b> .
Domain Name	Enter the domain name.
IPv4 address	Enter the domain IP address and click <b>Add</b> .
Origin Domain	Enter the origin domain name.
New Domain	Associate an origin domain with a new domain and click <b>Add</b> .
DNS table	Displays the configured domain name along with the IPv4 address.

You can click **Delete** to delete a particular Domain Name.

You can click  to update the displayed information.

END OF STEPS

## 8.27 Configuring TR-069

1

Click **Network**→**TR-069** from the left pane. The TR-069 page displays.

Figure 8-23 TR-069 page

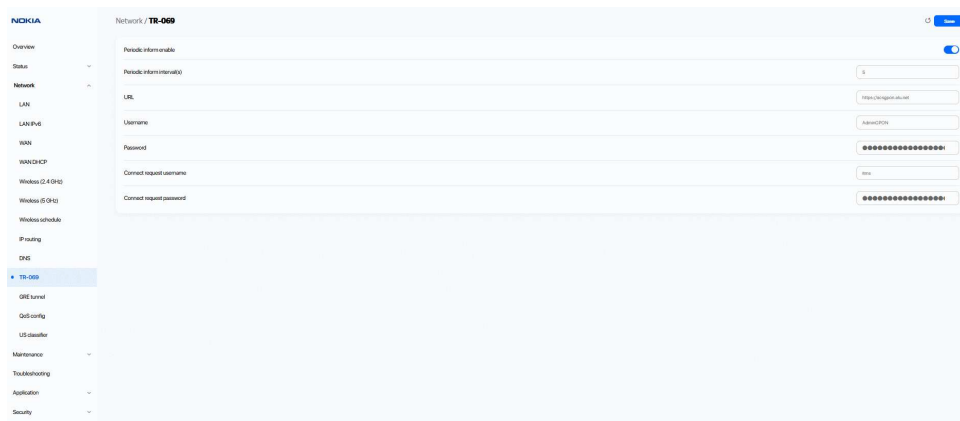

2

Configure the following parameters:

Table 8-19 TR-069 parameters

Field	Description
Periodic inform enable	Click to enable periodic inform updates.
Periodic inform interval(s)	Enter the time between periodic inform updates, in seconds.
URL	Enter the URL of the auto-configuration server.
Username	Enter the username used to log in to the auto-configuration server.
Password	Enter the password used to log in to the auto-configuration server.
Connect request username	Enter the username used to log in to the ONT.
Connect request password	Enter the password used to log in to the ONT.

3

Click **Save**.You can click  to update the displayed information.

END OF STEPS

## 8.28 Configuring GRE tunnel

**i** **Note:** This feature is available to admin users (super users) only.

1

Click **Network**→**GRE Tunnel** from the left pane. The GRE Tunnel page displays.

Figure 8-24 GRE Tunnel page

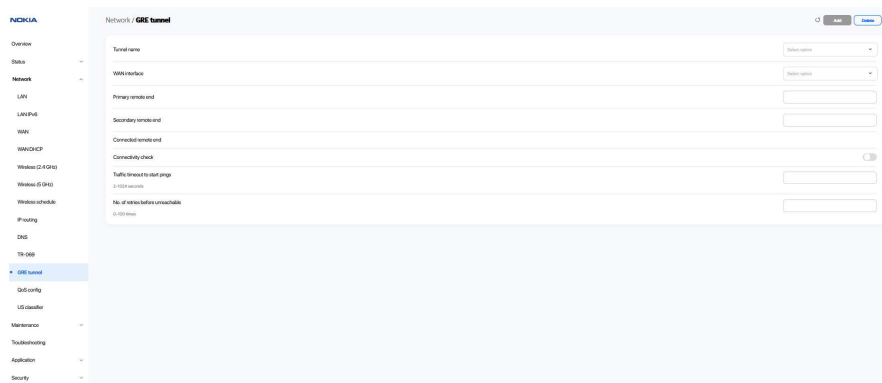

2

Configure the following parameters:



Table 8-20 GRE Tunnel parameters

Field	Description
Tunnel Name	Select <b>Create new GRE Tunnel</b> or select an existing tunnel from the list. The tunnel name is automatically assigned by the system. Up to 4 GRE tunnels are supported.
WAN Interface	Select a WAN interface from the list. GRE tunnels can only be created on HSI-enabled WAN interfaces.
Primary Remote End Secondary Remote End (optional)	Enter an IP address or FQDN that is unique in the system. If the primary remote endpoint is down or unreachable, the secondary remote endpoint becomes active, if configured. The secondary remote endpoint remains active until it becomes unreachable, in which case the primary remote endpoint becomes active again. Revertive mode is not supported. If both endpoints are unreachable, the GRE tunnel is declared down.
Connected Remote End	This field displays the current data traffic path for the GRE tunnel.
Connectivity check	This feature is automatically selected by the system.
Traffic timeout to start pings	Enter the traffic timeout in seconds (2 to 1024).
No. of retries before unreachable	Enter the number of retries before the tunnel is declared down (0 to 100).

3

Click **Save**.

You can click **Delete** to delete the entries.

END OF STEPS

## 8.29 Configuring Upstream (US) Classifier

The US Classifier feature is used to create policies, classifiers, and classifier rules for upstream traffic handling. This feature is available to admin users (super users) only.

A policy defines an action to be performed on a set of LAN or WAN packets. A policy can be created at any time and then subsequently assigned to one or more classifiers.

A classifier is used to select key fields for which the classifier rules will be written. A classifier can be created at any time and then subsequently assigned to one or more classifier rules.

A classifier rule is used to assign actions to a group of packets based on a set of parameters. A classification rule must be created against a pre-defined classifier.

Up to 16 policies can be created, with up to 8 classifiers and 32 classifier rules.

1

Click **Network**→**US Classifier** from the left pane and select the **Policy** tab.

All classifier policies are displayed in the policy table in the page.

Figure 8-25 US Classifier Policy page

2

Configure the following parameters:

Table 8-21 US Classifier Policy parameters

Field	Description
Tunnel Type	The tunnel type is set to GRE and cannot be modified.
Tunnel Interface	Select a tunnel interface from the list: No Tunnel, GRE Tunnel, or LAN traffic.
VLAN ID	Enter a VLAN ID (0-4094).
VLAN Tag	This field is not configurable. The VLAN tag is set to 8100 (hexadecimal). Determines the VLAN tag used inside the GRE tunnel.
VLAN Priority	Enter a VLAN priority level (0 to 7). A lower number indicates a higher priority.
IP TOS/DSCP	This field is not configurable. All tunnel packets are generated with a default DSCP value (usually 0).
Drop	Click to enable dropping of the packets.

3

Click **Save**.

You can click **Reset** to reset the configured values.

4

To delete a policy, click **Delete** for the applicable policy in the policy table.

A policy can only be deleted if it is not associated with any classifier rules.

You can click  to update the displayed information.

5

Click **Network**→**US Classifier** from the left pane and select the **Classifier** tab.  
 All classifiers are displayed in the classifier table in the page.

Figure 8-26 US Classifier page

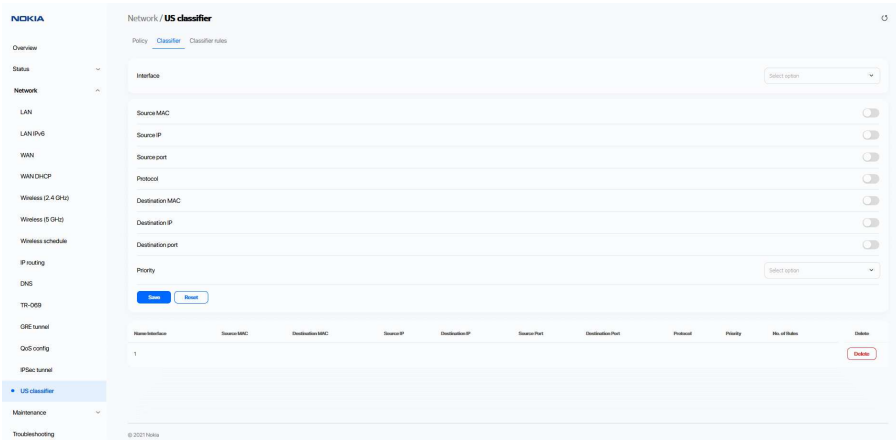

6

Configure the following parameters:

At least one field must be selected to create a classifier. A maximum of four fields may be selected to create a classifier; this includes the interface field.

Table 8-22 US Classifier parameters

Field	Description
Interface	Select an interface from the list; for example, None, LAN, 2.4G SSID, or 5G SSID. The option <b>None</b> indicates that all interfaces are selected.
Source MAC	Click to enter a source MAC address.
Source Port	Click to enter a source port.
Source IP	Click to enter a source IP address.
Protocol	Click to enter a protocol.
Destination MAC	Click to enter a destination MAC address.
Destination IP	Click to enter a destination IP address.
Destination Port	Click to enter a destination port.
Priority	Select a priority level from 1 to 8. The lower the number, the higher the priority. No more than 1 classifier can be created with the same priority.

7

Click **Save**.

You can click **Reset** to reset the configured values.

8

To delete a classifier, click **Delete** for the applicable classifier in the classifier table.

A classifier can only be deleted if it is not associated with any classifier rules.

You can click  to update the displayed information.

9

Select the **Classifier Rules** tab.

All classifier rules are displayed in the classifier rules table in the page.

Figure 8-27 US Classifier Rules page



10

Configure the following parameters:

Table 8-23 US Classifier Rules parameters

Field	Description
Policy	Select a policy from the list.
Classifier	Select a classifier from the list.
Interface	Select an interface from the list; for example, None, LAN, 2.4G SSID, 5G SSID.
Source MAC	Enter a source MAC address.
Destination MAC	Enter a destination MAC address.
Source IP	Enter a source IP address.

Table 8-23 US Classifier Rules parameters (continued)

Field	Description
Destination IP	Enter a destination IP address.
Source Port	Enter a source port.
Destination Port	Enter a destination port.
IP Protocol Type	Enter a value between 0 and 254.

11

Click **Save**.

You can click **Reset** to reset the configured values.

12

To delete a classifier rule, click **Delete** for the applicable classifier rule in the classifier rules table.

You can click  to update the displayed information.

END OF STEPS

## 8.30 Configuring QoS

1

Click **Network**→**QoS Config** from the left pane. The QoS Config page displays.

Figure 8-28 QoS Config page (L3 packet sizes)

**NOKIA** Network / QoS config Add

ID	Source MAC	Source MAC exclude	Protocol	Protocol exclude	Source port	Source port max	S Exclude	Dest Port	Dest Port Max	D Exclude	Source IP	Source IP mask	S Exclude	Dest IP	Dest IP Mask	D Exclude	DSCP	DSCP Remark	Delete
ID112																			Delete

Type L3 Criteria

**Classification criteria**

Protocol None

Exclude

Application Select option

Source IP

Source IP mask

Exclude

Dest IP

Dest IP mask

Exclude

© 2021 Nokia

Figure 8-29 QoS Config page (L3 packet sizes) continued

IPSec tunnel

US classifier

Maintenance

Troubleshooting

Application

Security

Dest IP mask

Exclude

Source port

Source port max

Exclude

Dest port

Dest port max

Exclude

802.1p

Interface Select option

**Classification row**

DSCP remark   
Range 0-63

802.1p Remark   
Range 0-7

Forwarding policy   
Range 1-7

**2**

Configure the following parameters:

Table 8-24 QoS Config parameters

Field	Description
<b>QoS Setting</b>	
Type	Select a QoS service layer type from the list <b>L2 Criteria</b> or <b>L3 Criteria</b> .
<b>Classification Criteria</b>	
Source MAC	Enter the source MAC address. Click <b>Exclude</b> to exclude the source MAC address.
Interface	Select an interface from the list.
<b>Classification Row</b>	
DSCP remark	Enter the value for the DSCP mark (range: 0-63); valid only for L3 Criteria.
802.1p Remark	Enter the value for the 802.1p (range: 0-7).
Forwarding Policy	Enter the number for the forwarding policy (range: 1-7).
<b>Additional fields for L3 Criteria</b>	
Protocol	Select a protocol from the list, or click <b>Exclude</b>
Application	Select an application from the list.
Source IP and Source IP Mask	Enter the values for the source IP and IP mask, or click <b>Exclude</b> .
Destination IP and Destination IP Mask	Enter the values for the destination IP and IP mask, or click <b>Exclude</b> .
Source Port and Source Port Max	Enter the values for the source port and port max (highest port number) or click <b>Exclude</b> .
Destination Port and Destination Port Max	Enter the values for the destination port and port max (highest port number), or click <b>Exclude</b> .

**3**

Click **Add** to add a QoS policy.

**END OF STEPS**

## Security configuration

### 8.31 Overview

#### 8.31.1 Purpose

This chapter describes the security configuration tasks supported by XS-2426G-B ONTs

#### 8.31.2 Contents

<a href="#">8.31 Overview</a>	120
<a href="#">8.32 Configuring the firewall</a>	120
<a href="#">8.33 Configuring the MAC filter</a>	121
<a href="#">8.34 Configuring the IP filter</a>	122
<a href="#">8.35 Configuring the URL filter</a>	123
<a href="#">8.36 Configuring DMZ and ALG</a>	124
<a href="#">8.37 Configuring access control</a>	125

### 8.32 Configuring the firewall

1

Click **Security**→**Firewall** from the left pane. The Firewall page displays.

Figure 8-30 Firewall page

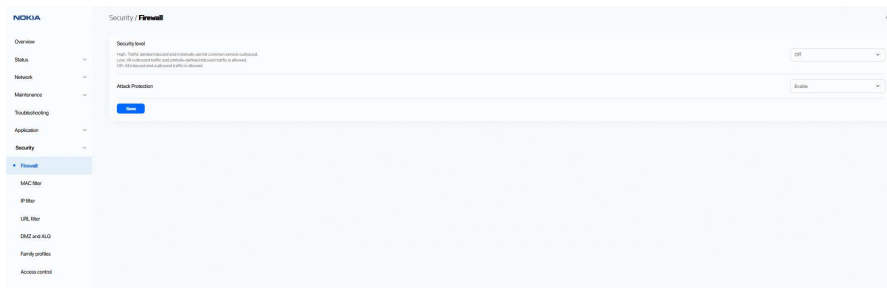

2

Configure the following parameters.



Table 8-25 Firewall parameters

Field	Description
Security level	Select the security level from the list: <b>High:</b> Traffic denied inbound and minimally permit common services outbound <b>Low:</b> All outbound traffic and pinhole-defined inbound traffic is allowed <b>Off:</b> All inbound and outbound traffic is allowed
Attack Protection	Select <b>Enable</b> or <b>Disable</b> from the list. The default is <b>Enable</b> .

3

Click **Save**.

You can click  to update the displayed information.

END OF STEPS

### 8.33 Configuring the MAC filter

1

Click **Security**→**MAC Filter** from the left pane. The MAC Filter page displays.

Figure 8-31 MAC Filter page

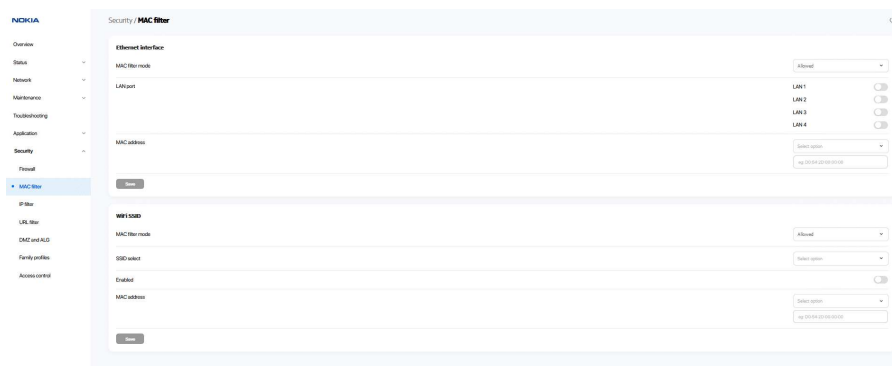

2

Configure the following parameters:

Table 8-26 MAC Filter parameters

Field	Description
<b>Ethernet Interface</b>	

Table 8-26 MAC Filter parameters (continued)

Field	Description
MAC filter mode	Select the MAC filter mode from the list: Blocked or Allowed.
LAN port	Click on either one of the ports : LAN1, LAN2, LAN3, LAN4
MAC address	Select the MAC address from the list or enter the address in the text field.
<b>Wi-Fi SSID</b>	
MAC Filter Mode	Select the MAC filter mode from the list: Blocked or Allowed.
SSID Select	Select the SSID from the list.
Enable	Click to enable the MAC filter.
MAC Address	Select a MAC address from the list or enter the address in the text field.
MAC Address Description	Enter the MAC address description.

3

Click **Save**.You can click  to update the displayed information.

END OF STEPS

## 8.34 Configuring the IP filter

1

Click **Security**→**IP Filter** from the left pane. The IP Filter page displays.

Figure 8-32 IP Filter page



2

Configure the following parameters:

Table 8-27 IP Filter parameters

Field	Description
Enable IP Filter	Click to enable an IP filter.
Mode	Select an IP filter mode from the list: <ul style="list-style-type: none"> <li>• <b>Drop for upstream</b></li> <li>• <b>Drop for downstream</b></li> </ul>
Internal Client	Select an internal client from the list: <ul style="list-style-type: none"> <li>• <b>Custom settings:</b> uses the IP address input below</li> <li>• <b>IP:</b> uses the connecting devices' IP to the ONT</li> </ul>
Local IP Address	Enter the local IP address.
Source subnet mask	Enter the source subnet mask.
Remote IP address	Enter the remote IP address.
Destination subnet mask	Enter the destination subnet mask.
Protocol	Select an application protocol or <b>ALL</b> from the list.

3

Click **Save**.

You can click  to update the displayed information.

END OF STEPS

## 8.35 Configuring the URL filter

1

Click **Security**→**URL Filter** from the left pane. The URL Filter page displays.

Figure 8-33 URL Filter page

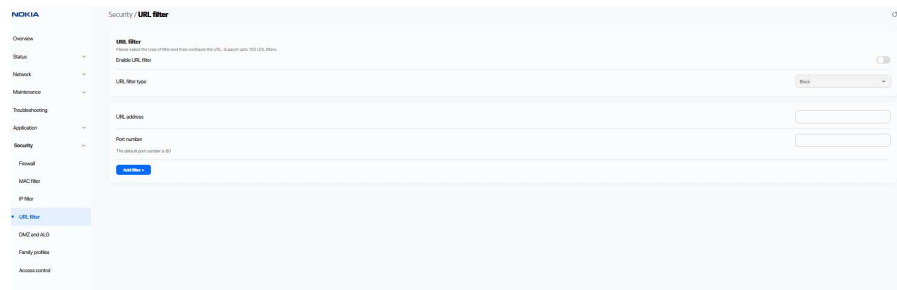

**Note:** You cannot use URL filtering for HTTPS. The URL is encrypted when using HTTPS.

2

Configure the following parameters:

Table 8-28 URL Filter parameters

Field	Description
Enable URL filter	Click to enable the URL filter.
URL filter type	Select the option to block the URL or allow the URL.
<b>URL List</b>	
URL Address	Enter the URL address.
Port - default to 80	Enter the port number; the default is 80.

3

Click **Add Filter**.

END OF STEPS

## 8.36 Configuring DMZ and ALG

1

Click **Security**→**DMZ and ALG** from the left pane. The DMZ and ALG page displays.

Figure 8-34 DMZ and ALG page

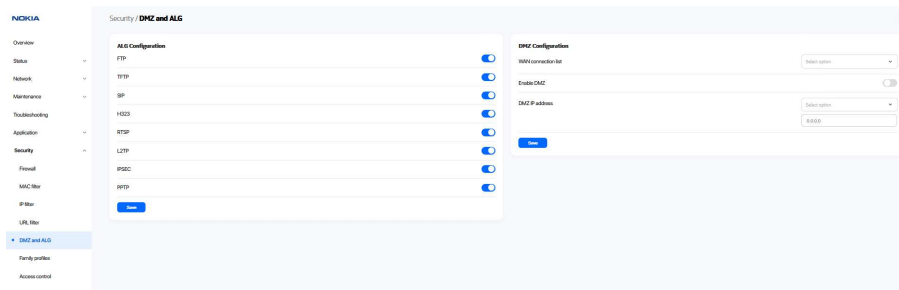

2

Configure the following parameters:

Table 8-29 ALG parameters

Field	Description
ALG Configuration	Select the checkboxes to enable the protocols to be supported by the ALG: FTP, TFTP, SIP, H323, RTSP, L2TP, IPSEC, PPTP.

3 \_\_\_\_\_  
 Click **Save ALG**.

4 \_\_\_\_\_  
 Configure the following parameters:

Table 8-30 DMZ parameters

Field	Description
WAN connection list	Select a WAN connection from the list.
Enable DMZ	Click to enable DMZ on the selected WAN connection.
DMZ IP Address	Select <b>Custom Settings</b> and enter the DMZ IP address or select the IP address of a connected device from the list.

5 \_\_\_\_\_  
 Click **Save DMZ**.

END OF STEPS \_\_\_\_\_

## 8.37 Configuring access control

This procedure describes how to configure the access control level (ACL).

**i** **Note:** ACL takes precedence over the firewall policy.  
 The trusted network object will be shared for all WAN connections; it is not applied individually to a WAN connection.

1 \_\_\_\_\_  
 Click **Security**→**Access Control** from the left pane. The Access Control page displays.

Figure 8-35 Access Control page

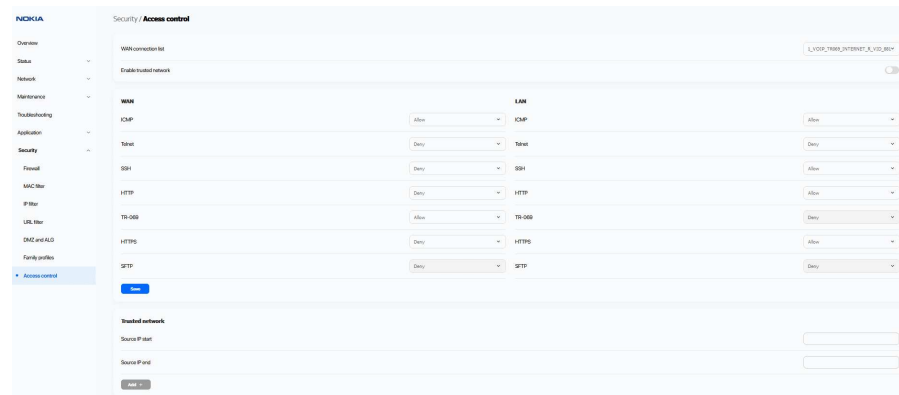

**2**

Configure the following parameters:

Table 8-31 Access Control parameters

Field	Description
WAN connection list	Select a connection from the list.
Enable trusted network	Click to enable or disable trusted network.
ICMP, Telnet, SSH, HTTP, TR-069, HTTPS, SFTP	Select an access control level for each protocol: WAN side: Allow, Deny, or Trusted Network Only LAN side: Allow or Deny

**3**Click **Save** to save the access control configuration.You can click  to update the displayed information.**4**

Optionally, add one or more subnet trusted networks.

The maximum number of entries is 32.

You can also use the Source IP fields to delete a previously created entry for a subnet trusted network.

Table 8-32 Trusted Network parameters

Field	Description
<b>Trusted Network</b>	
Source IP Start	Enter a start IP address for the new subnet trusted network.
Source IP End	Enter an end IP address for the new subnet trusted network.

**5**Click **Add**.**END OF STEPS**

## Configuring the Application

### 8.38 Overview

#### 8.38.1 Purpose

This chapter describes the application configuration tasks supported by the XS-2426G-B ONTs.

#### 8.38.2 Contents

8.38 Overview	127
8.39 Configuring port forwarding	127
8.40 Configuring port triggering	128
8.41 Configuring DDNS	129
8.42 Configuring NTP	130
8.43 Configuring USB	131
8.44 Configuring UPnP and DLNA	132

### 8.39 Configuring port forwarding

1

Click **Application**→**Port Forwarding** from the left pane. The Port Forwarding page displays.

Figure 8-36 Port Forwarding page

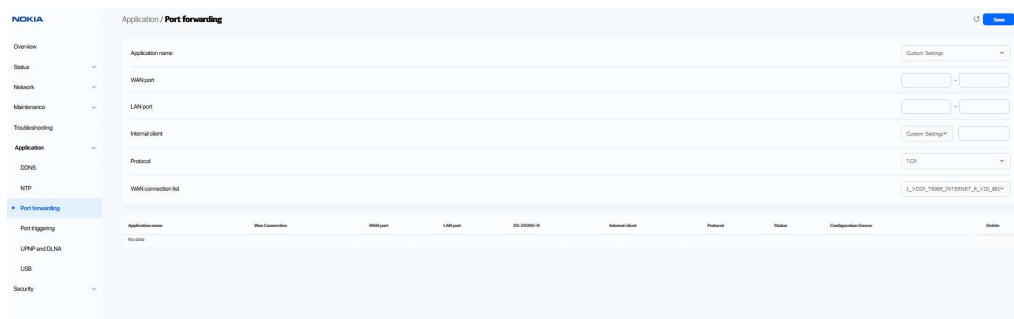

2

Configure the following parameters:

Table 8-33 Port Forwarding parameters

Field	Description
Application Name	Select an application name from the list. The default is <b>Custom settings</b> .
WAN Port	Enter the WAN port range.
LAN Port	Enter the LAN port range.
Internal Client	Select a connected device from the list and enter the associated IP address.
Protocol	Select the port forwarding protocol from the list: <ul style="list-style-type: none"> <li>• TCP</li> <li>• UDP</li> <li>• TCP/UDP</li> </ul>
WAN connection list	Select a WAN connection from the list. Note: Only active devices are shown on this list.

3

Click **Add**.Click **Delete** to delete a port forwarding configuration.

END OF STEPS

## 8.40 Configuring port triggering

1

Click **Application**→**Port Triggering** from the left pane. The Port Triggering page displays.

Figure 8-37 Port Triggering page

2

Configure the following parameters:



Table 8-34 Port Triggering parameters

Field	Description
Application Name	Select an application name from the list. The default is <b>Custom settings</b> .
Open Port	Enter the open port range.
Triggering Port	Enter the triggering port range.
Expire Time	Enter the expiration time in seconds.
Open Protocol	Select the open port protocol from the list: <ul style="list-style-type: none"> <li>• TCP</li> <li>• UDP</li> <li>• TCP/UDP</li> </ul>
Trigger Protocol	Select the triggering port protocol from the list: <ul style="list-style-type: none"> <li>• TCP</li> <li>• UDP</li> <li>• TCP/UDP</li> </ul>
Enable Triggering	Select this checkbox to enable port triggering.
WAN Connection List	Select a WAN connection from the list. Note: Only active devices are shown on this list.

3

Click **Add**.

END OF STEPS

## 8.41 Configuring DDNS

1

Click **Application** → **DDNS** from the left pane. The DDNS page displays.

Figure 8-38 DDNS page



2

Configure the following parameters:

Table 8-35 DDNS parameters

Field	Description
WAN Connection List	Select a WAN connection from the list.
Enable DDNS	Click to enable DDNS on the selected WAN connection.
ISP	Select an ISP from the list.
Domain Name	Enter the domain name.
Username	Enter the username.
Password	Enter the password.

3

Click **Save**.

You can click  to update the displayed information.

END OF STEPS

## 8.42 Configuring NTP

1

Click **Application**→**NTP** from the left pane. The NTP page displays.

Figure 8-39 NTP page

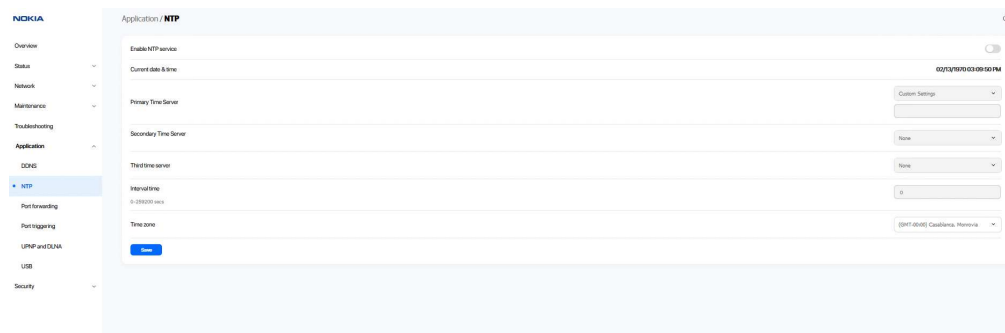

2

Configure the following parameters:

Table 8-36 NTP parameters

Field	Description
Enable NTP Service	Click to enable the NTP service.
Current date& time	Enter the current local date and time.
Primary Time Server	Select a time server from the list or select <b>Custom settings</b> and enter the address of the time server.
Secondary Time Server	Select a time server from the list or select <b>Custom settings</b> and enter the address of the time server.
Third Time Server	Select a time server from the list or select <b>Custom settings</b> and enter the address of the time server.
Interval Time	Enter the interval at which to get the time from the time server, in seconds.
Time Zone	Select the local time zone from the list.

3

Click **Save**.

You can click  to update the displayed information.

END OF STEPS

## 8.43 Configuring USB

You can connect USB storage devices and USB printers to the USB ports of the device. The USB menu enables you to configure FTP and SFTP for your USB storage devices.

The USB connected devices are shown in overview table on the bottom of the USB page.

1

Click **Application**→**USB** from the left pane. The USB page displays.

Figure 8-40 USB page



2

Configure the following parameters:

Table 8-37 USB parameters

Field	Description
Enable FTP server	Click to enable using an FTP server.
Username	Enter the username for the FTP server.
Password	Enter the password for the FTP server.
Re-enter Password	Re-enter the password for the FTP server.

3

Click **Save**.

You can click  to update the displayed information.

END OF STEPS

## 8.44 Configuring UPnP and DLNA

1

Click **Application**→**UPnP and DLNA** from the left pane. The UPnP and DLNA page displays.

Figure 8-41 UPnP and DLNA page

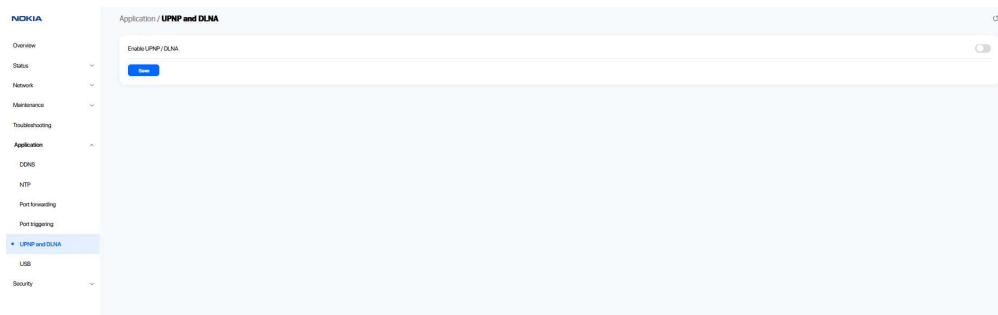

2

Click **Enable UPnP/DLNA** to enable UPnP/DLNA.

3

Click **Save/Apply**.

END OF STEPS

## Maintenance

### 8.45 Overview

#### 8.45.1 Purpose

This chapter describes the maintenance tasks supported by XS-2426G-B ONTs.

#### 8.45.2 Contents

8.45 Overview	133
8.46 Configuring the password	133
8.47 Configuring LOID	134
8.48 Configuring SLID	135
8.49 Managing the device	136
8.50 Backing up the configuration	137
8.51 Restoring the configuration	138
8.52 Upgrading firmware	139
8.53 Rebooting the device	139
8.54 Resetting to factory defaults	140
8.55 Diagnosing WAN connections	141
8.56 Viewing log files	142

### 8.46 Configuring the password

A password must adhere to the password rules, which are as follows:

- The password may consist of uppercase letters, lowercase letters, digital numbers, and the following special characters ! # + , - / @ \_ : = ]
- The password length must be from 8 to 24 characters
- The first character must be a digital number or a letter
- The password must contain at least two types of characters: numbers, letters, or special characters
- The same character must not appear more than 8 times in a row

When the password meets the password rules, the application displays the message “Your password has been changed successfully”.

When the password does not meet the password rules, the application displays a message to indicate which password rule has not been followed, for example:

- The password is too short
- The password is too long

- The first character cannot be a special character
- There are not enough character classes

1

Click **Maintenance** → **Password** from the left pane. The Password page displays.

Figure 8-42 Password page

2

Configure the following parameters:

Table 8-38 Password parameters

Field	Description
Original Password	Enter the current password.
New Password	Enter the new password (must adhere to the password rules).
Re-enter password	Re-enter the new password (must match the new password entered above exactly).
Prompt message	Enter the password prompt message.

3

Click **Save**.

You can click  to update the displayed information.

END OF STEPS

## 8.47 Configuring LOID

1

Click **Maintenance** → **LOID Config** from the left pane. The LOID Config page displays.

Figure 8-43 LOID Config page

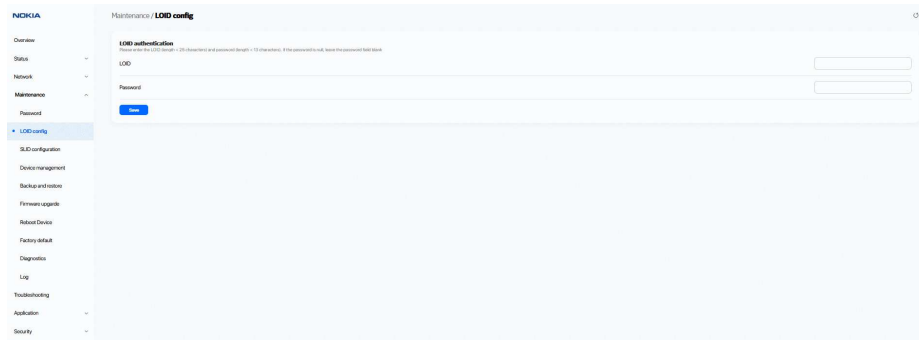

2

Configure the following parameters:

Table 8-39 LOID Configuration parameters

Field	Description
LOID authentication	
LOID	Enter the LOID; the maximum number of characters is 24 If the password is null, this field may be left blank.
Password	Enter the password; the maximum number of characters is 12.

3

Click **Save**.

END OF STEPS

## 8.48 Configuring SLID

1

Click **Maintenance**→**SLID Configuration** from the left pane. The SLID Configuration page displays.

Figure 8-44 SLID Configuration page

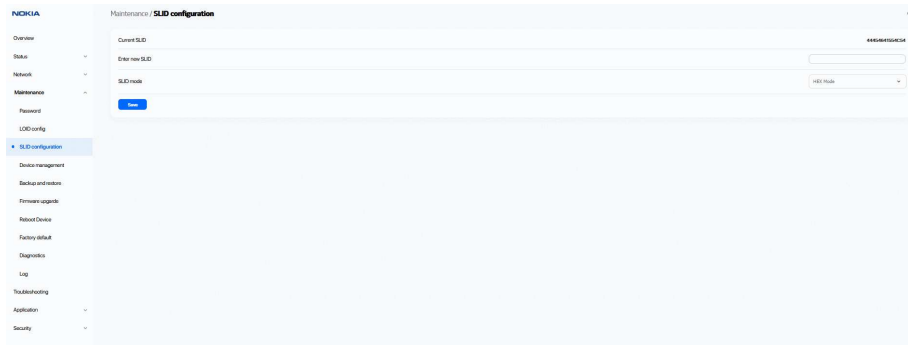

2

Configure the following parameters:

Table 8-40 SLID Configuration parameters

Field	Description
Current SLID	Displays the current SLID.
Enter New SLID	Enter the new SLID.
SLID Mode	Select a SLID mode from the list. The default is HEX Mode.

3

Click **Save**.

You can click  to update the displayed information.

END OF STEPS

## 8.49 Managing the device

1

Click **Maintenance**→**Device Management** from the left pane. The Device Management page displays.



Figure 8-45 Device Management page

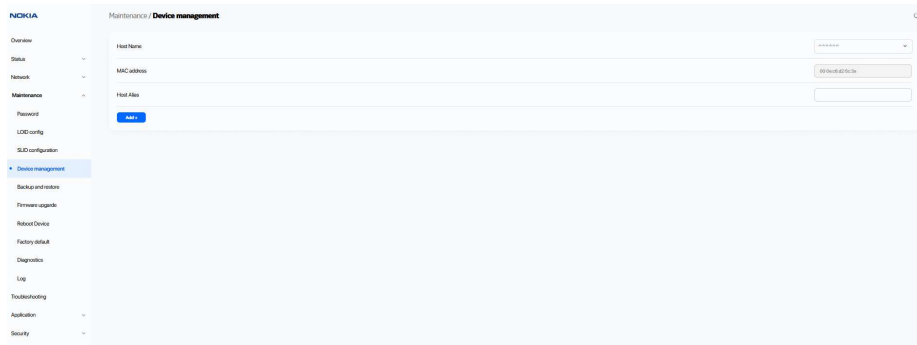

2

Configure the following parameters:

Table 8-41 Device Management parameters

Field	Description
Host Name	Select a hostname from the list.
MAC address	Indicates the MAC address.
Host Alias	Enter an alias for the selected host.

3

Click **Add**.

You can click  to update the displayed information.

END OF STEPS

## 8.50 Backing up the configuration

1

Click **Maintenance**→**Backup and Restore** from the left pane. The Backup and Restore page displays.

Figure 8-46 Backup and Restore page

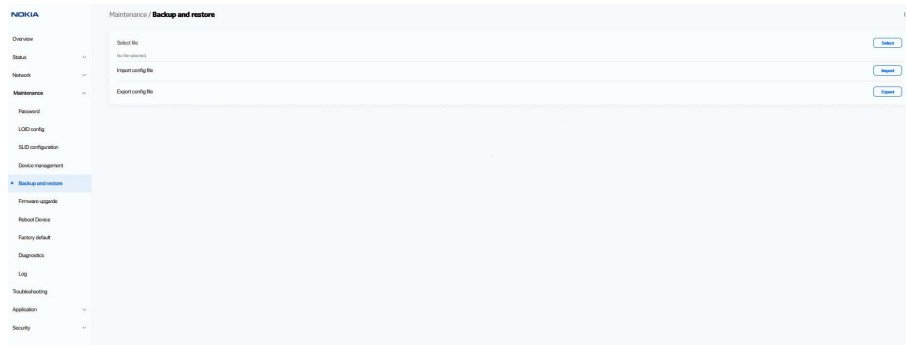

2

Click **Select** to select the file to export.

3

Click **Export** to export the current ONT configuration to a backup file.

END OF STEPS

## 8.51 Restoring the configuration

1

Click **Maintenance**→**Backup and Restore** from the left pane. The Backup and Restore page displays.

Figure 8-47 Backup and Restore page

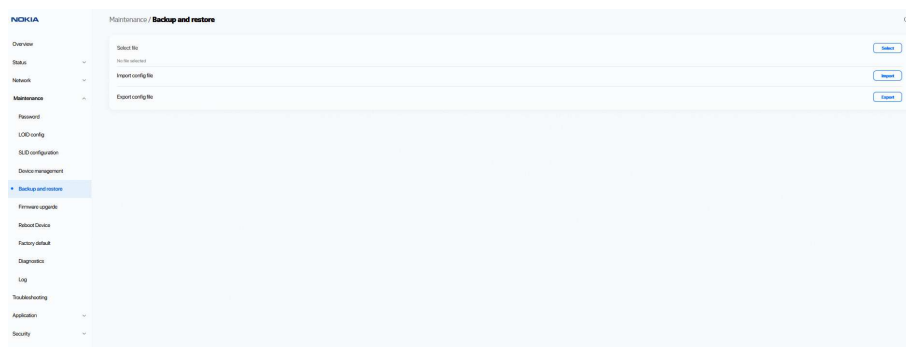

2

Click **Select** and select the backup file.

3

Click **Import** to restore the ONT to the saved backup.

END OF STEPS

## 8.52 Upgrading firmware

1

Click **Maintenance**→**Firmware Upgrade** from the left pane. The Firmware Upgrade page displays.

Figure 8-48 Firmware Upgrade page

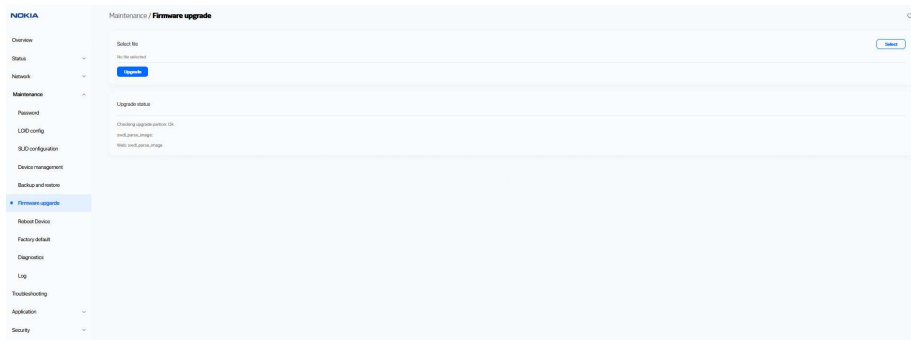

2

Click **Select** and select the firmware file.

3

Click **Upgrade** to upgrade the firmware.

END OF STEPS

## 8.53 Rebooting the device

1

Click **Maintenance**→**Reboot Device** from the left pane. The Reboot Device page displays.

Figure 8-49 Reboot Device page

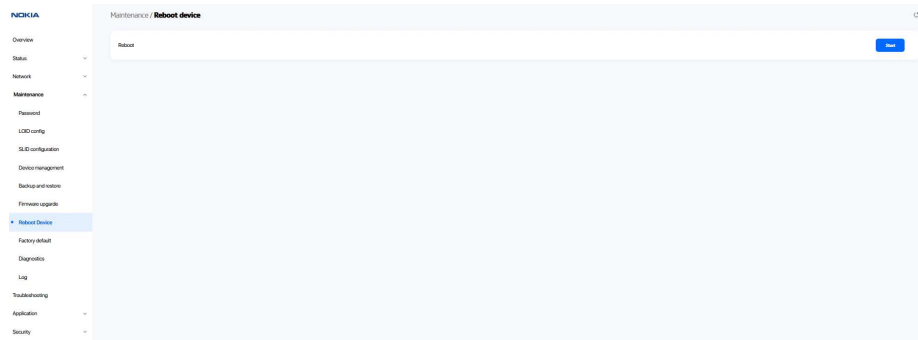

2

Click **Reboot** to reboot the ONT.

END OF STEPS

## 8.54 Resetting to factory defaults

1

Click **Maintenance**→**Factory Default** from the left pane. The Factory Default page displays.

Figure 8-50 Factory Default page

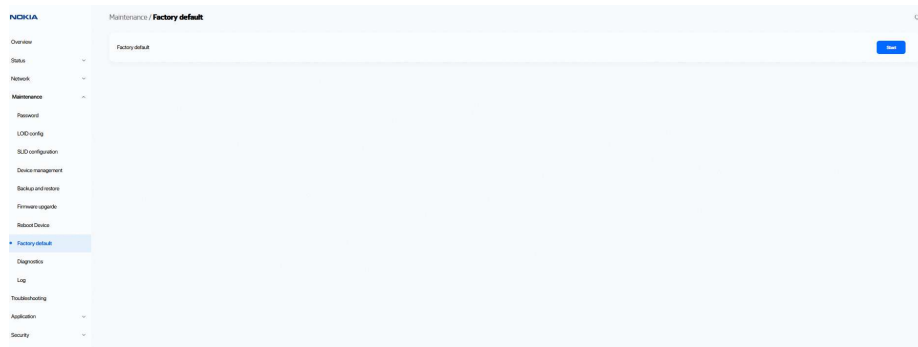

2

Click **Factory Default** to reset the ONT to its factory default settings.

END OF STEPS

## 8.55 Diagnosing WAN connections

1

Click **Maintenance**→**Diagnostics** from the left pane. The Diagnostics page displays.

Figure 8-51 Diagnostics page

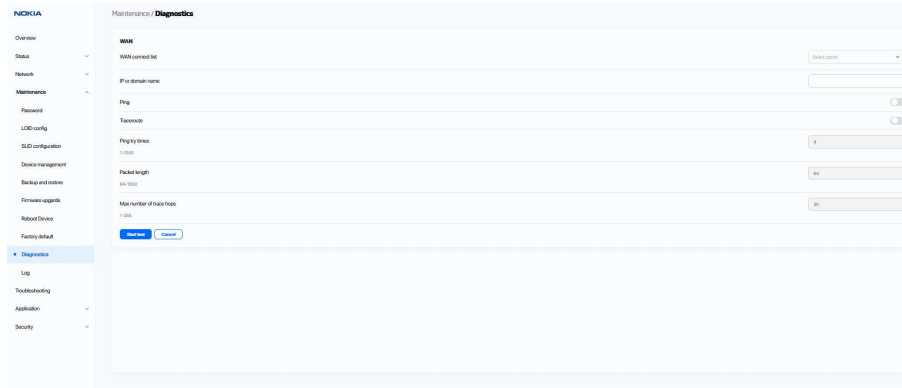

2

Select a WAN connection to diagnose from the list.

3

Enter the IP address or domain name.

4

Click to select the test type: ping, traceroute, or both.

5

Enter the number of ping attempts to perform (1 - 1000); the default is 4.

6

Enter a ping packet length (64-1024); the default is 64.

7

Enter the maximum number of trace hops (1-255); the default is 30.

8

Click **Start Test**. The results will be displayed at the bottom of the page.

9

Click **Cancel** to cancel the test.

END OF STEPS

## 8.56 Viewing log files

1

Click **Maintenance**→**Log** from the left pane. The Log page displays.

Figure 8-52 Log page

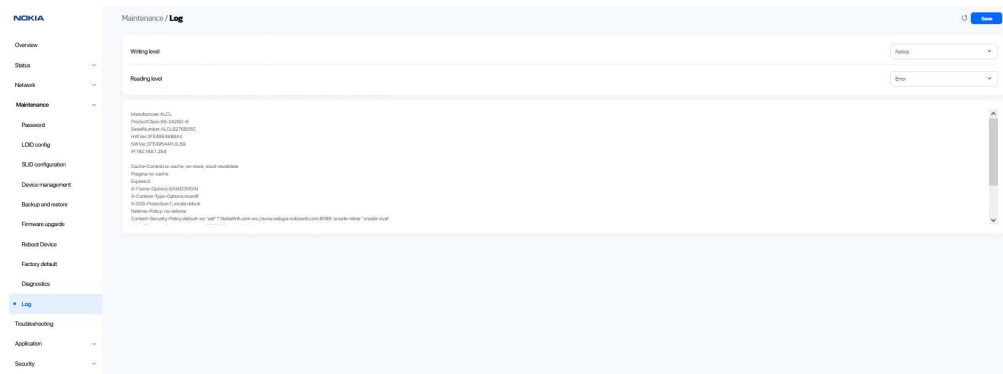

2

Select a write level from the list to determine which types of events are recorded in the log file:

- Emergency
- Alert
- Critical
- Error
- Warning
- Notice
- Informational
- Debug

3

Select a reading level from the list to determine which types of events to display from the log file:

- Emergency
- Alert
- Critical

- 
- Error
  - Warning
  - Notice
  - Informational
  - Debug

The log file is displayed at the bottom of the page.

**4**

---

Click **Save**.

You can click  to update the displayed information.

**END OF STEPS**

---

## RG Troubleshooting Counters

### 8.57 Overview

#### 8.57.1 Purpose

This section describes the RG troubleshooting counters GUI procedures.

#### 8.57.2 Contents

<a href="#">8.57 Overview</a>	144
<a href="#">8.58 Viewing Residential Gateway (RG) troubleshooting counters</a>	144

### 8.58 Viewing Residential Gateway (RG) troubleshooting counters

The Troubleshooting Counters feature enables service providers and end users to monitor the performance of their broadband connection.

Tests are run to retrieve upstream and downstream throughput, latency, and DNS response time. The Troubleshooting Counters page also displays upstream and downstream packet loss and Internet status.

#### 1

Click **RG Troubleshooting** → **RG Troubleshoot Counters** from the left menu . The RG Troubleshoot Counters page displays.

Figure 8-53 RG Troubleshooting Counters page

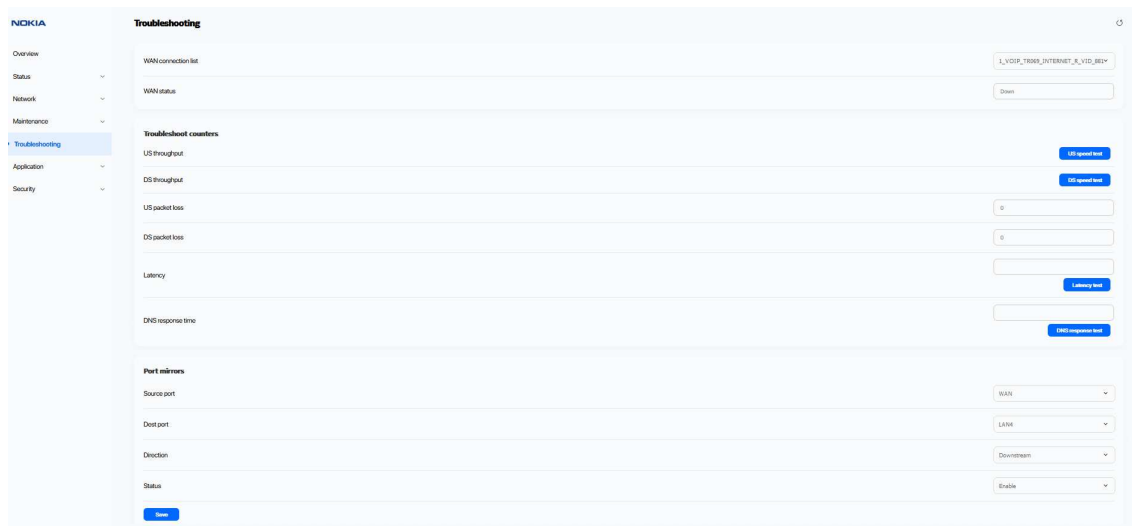



2

Configure the following parameters:

Table 8-42 RG Troubleshooting Counters parameters

Field	Description
WAN Connection List	Select a WAN connection from the list.
WAN Status	Indicates whether the broadband connections is active (UP) or not (DOWN).
US Throughput	This test is used to determine the upstream throughput/speed. Click <b>US Speed Test</b> to specify the time for the upstream test. The default is weekly, performed at idle to a public server.
DS Throughput	This test is used to determine the downstream throughput/speed. Click <b>DS Speed Test</b> to specify the time for the downstream test. The default is weekly, performed at idle to a public server.
US Packet Loss	Displays the number of upstream packages lost.
DS Packet Loss	Displays the number of downstream packages lost.
Latency	This test is used to determine the lowest round-trip time in milliseconds by pinging the target server multiple times. Click <b>Latency Test</b> to specify the time for the test. The default is weekly, performed at idle to a public server.
DNS Response Time	This test is used to determine the lowest round-trip time in milliseconds by sending a request to the target DNS server. Click <b>DNS Response Test</b> to specify the time for the test. The default is weekly, performed at idle to a public server.
Port mirrors	
Source port	Select a source port from the list.
Dest port	Select a destination port from the list.
Direction	Select a direction from the list ( upstream or downstream).
Status	Select a status from the list

3

Click **Save**.

You can click 

END OF STEPS



## 9 ONT configuration file over OMCI

### 9.1 Overview

#### 9.1.1 Purpose

#### 9.1.2 Contents

<a href="#">9.1 Overview</a>	147
<a href="#">9.2 Purpose</a>	147
<a href="#">9.3 Supported configuration file types</a>	147
<a href="#">9.4 ONT configuration file over OMCI</a>	149

### 9.2 Purpose

This procedure describes how to use configuration files over OMCI to configure ONTs. Some advantages include:

- Flexibility to change the ONT default behavior by downloading configuration file
- Flexibility to update a deployed ONT by downloading updated parameters
- Ability to securely download any configuration file to an ONT
- Ability to avoid using embedded configuration files in ONT software

**i** **Note:** This feature is supported for use with the 7360 ISAM FX and the 7342 ISAM FTTU.

### 9.3 Supported configuration file types

[Table 9-1, “Supported configuration files” \(p. 148\)](#) describes the configuration file types that are supported from Nokia ONT R05.02.00 and later.

Table 9-1 Supported configuration files

File Index	Description	Details	Supported ONTs/DPU
PRE	ONT pre-configuration file	<p>The XML-based PRECONFIG file controls the working mechanics of the ONT for various services. The default behavior of different ONTs may vary based on the factory settings.</p> <p>The pre-configuration file includes the factory default value for the residential gateway.</p> <p>Note: the pre-configuration file does not work with SFU ONTs; therefore, this feature applies only to Residential Gateway ONTs.</p> <p>The pre-configuration file can be used as is, but Nokia provides its customers with the flexibility to customize the pre-configuration file.</p> <p>This pre-configuration file enables operators to change the default behavior by downloading a customized pre-configuration based on customer inputs.</p> <p>This PRE XML file includes a custom OPERID.</p> <p>The Nokia defined index for the PRECONFIG file is: "PRE"</p>	All Nokia GPON and 10 GPON ONT.
CFG	ONT configuration delta file	<p>The XML-based CFG file updates the configurable parameters (the PRE settings) in the existing PRE file of a deployed ONT, where required.</p> <p>This configuration file enables operators to change the deployed behavior by downloading customized updates in the CFG file.</p> <p>This file is used only to modify the parameters in the PRE file; it is not used for service provisioning.</p> <p>No OPERID is required, because the update is based on the OPERID used for the PRE file.</p> <p>The Nokia defined index for the PRECONFIG DELTA file is: "CFG"</p>	All Nokia GPON and 10GPON ONT.
XML	Voice XML file	<p>The Voice XML file provides an alternate method for securely downloading voice parameters from the OLT, rather than using FTP (OMCIv1/OMCIv2) or HTTPS (TR-069). Downloading this file makes the applicable changes in the voice parameters.</p> <p>This file enables operators to change the voice behavior by downloading the updated voice XML file.</p> <p>Nokia recommends using this procedure, rather than embedded voice XML files.</p> <p>The Nokia defined index for the Voice XML file is: "XML"</p>	All Nokia GPON and 10 GPON ONT.

Table 9-1 Supported configuration files (continued)

File Index	Description	Details	Supported ONTs/DPU
GFT	G.fast-related configuration file	<p>This text-based json script file controls the default behavior of the G.Fast ONT.</p> <p>This file includes the provisioning parameters of the G.fast transports layer; it does not include VLAN or QoS provisioning.</p> <p>While the ONT functions well with the default values; they can optionally be customized.</p> <p>While default values can work in VDSL mode, a download file is required for the device to function as a G.fast ONT.</p> <p>The Nokia defined index for the G.fast file is: "GFT"</p>	Nokia G.fast.

### 9.3.1 Filename conventions

Nokia provides the raw configuration files, which must be saved by the operator in a TAR file to be uploaded. TAR file names must be unique.

The filenames of the raw configuration files may not adhere to the naming conventions outlined below. In this case, the files must be renamed to adhere to the naming conventions before the operator generates the TAR file. Filenames are not case-sensitive.

### 9.3.2 Download configuration file

The following table provides the supported download options for ONT pre-configuration file and configuration file.

Table 9-2 Download configuration files

ONT type	Legacy method download		Zero management download	
	PRE file	CFG file	PRE file	CFG file
Broadlight(eg.I240WA-3FE54869AFGA80)	—	✓	—	✓
Broadcom(eg.G240WB-3FE56773BFGA07)	—	✓	✓	✓
MTK(eg.G240WF)	—	✓	✓	✓

## 9.4 ONT configuration file over OMCI



### WARNING

#### Equipment Damage

*Executing the following procedure will trigger the ONT to reboot, which will impact ongoing services.*

Use this procedures to configure ONTs using configuration files via legacy method and OMCI.

## 9.4.1 Configuring an ONT using a configuration file via legacy method

1

Upload the ABCXXXXVER TAR file to the /ONT/ directory in the OLT.  
A maximum of 250 files can be kept in the OLT file system.

2

Using OLT commands, download the TAR file to the ONT.

For OLT commands, refer to the , or the **7342 ISAM FTTU Operation and Maintenance Using TL1 and CLI**.

Please note:

- **pri-cfgfile-pland/dnload** or **sec-cfgfile-pland/dnload** can be 1 to 14 characters.
- **pri-cfgfile-pland** and **pri-cfgfile-dnload** should be the same name.

### Examples

Note: X can be 1 or 2 unless specified:

- If **pland-cfgfileX= Disabled** and **dnload-cfgfileX= Disabled** ,  
no file will be downloaded to the ONT.
- If **pland-cfgfileX=FILENAME1** and **dnload-cfgfileX= Disabled** ,  
FILENAME1 will be downloaded and FILENAME1 will be made active. An ONT reboot is required.
- If **pland-cfgfileX=Disabled** and **dnload-cfgfileX= FILENAME2**  
FILENAME2 will be downloaded and FILENAME2 will be made passive. An ONT reboot is not required.
- If **pland-cfgfileX=FILENAME3** and **dnload-cfgfileX= FILENAME 4**, the OLT reports an error because the filenames are not the same.
- Configure equipment interface **pland-cfgfile1=XMLXXXXXX1** and **dnload-cfgfile1 XMLXXXXXX1**  
Configure equipment interface **pland-cfgfile2=XMLXXXXXX2** and **dnload-cfgfile2 XMLXXXXXX2**  
Although the OLT permits the above two steps without reporting an error, Nokia does not recommend executing them, because the ONT may exhibit unexpected behavior.
- If **pland-cfgfileX=Auto** and **dnload-cfgfileX= Auto**  
The OLT will download the XML file from "sw-ctr-list" (**configure equipment ont sw-ctrl**)

### END OF STEPS

The ONT will distribute the configuration files to the different services based on the active indication from the OLT and on the Nokia defined index.

The ONT automatically reboots to apply the configuration files. After the ONT reboots and reports the active version, the OLT completes the file download procedure.

Operators must check the committed file from the OLT to verify whether the corresponding file has been applied. If an error occurs, contact Nokia for support.

## 9.4.2 Configuring an ONT using a configuration file via OMCI

1

Generate the TAR file to be uploaded to the OLT.

Using the raw configuration file(s) provided by Nokia, generate the TAR file as follows:

a. On a Linux platform, rename the raw configuration file to adhere to the naming convention, as described in section 9.3 “Supported configuration file types” (p. 147).

b. Tar the **ABCXXXXVER** raw configuration file:

```
tar -cf ABCXXXXVER.tar ABCXXXXVER
```

Where

**ABCXXXXVER**

Is the name of the file created in step i.

This creates two files: **ABCXXXXVER** and **ABCXXXXVER.tar**.

c. Rename **ABCXXXXVER** to **ABCXXXXVER.org**

d. Remove the “.tar” extension from **ABCXXXXVER.tar** file.

2

Upload the ABCXXXXVER TAR file to the /ONT/ directory in the OLT.

A maximum of 250 files can be kept in the OLT file system.

3

Using OLT commands, download the TAR file to the ONT.

For OLT commands, refer to the , or the **7342 ISAM FTU Operation and Maintenance Using TL1 and CLI**.

Please note:

- **pri-cfgfile-pland/dnload** or **sec-cfgfile-pland/dnload** can be 1 to 14 characters.
- **pri-cfgfile-pland** and **pri-cfgfile-dnload** should be the same name.

### Examples

Note: X can be 1 or 2 unless specified:

a. If **pland-cfgfileX= Disabled** and **dnload-cfgfileX= Disabled** ,  
no file will be downloaded to the ONT.

b. If **pland-cfgfileX=FILENAME1** and **dnload-cfgfileX= Disabled** ,

FILENAME1 will be downloaded and FILENAME1 will be made active. An ONT reboot is required.

c. If **pland-cfgfileX=Disabled** and **dnload-cfgfileX= FILENAME2**

---

FILENAME2 will be downloaded and FILENAME2 will be made passive. An ONT reboot is not required.

d. If **pland-cfgfileX=FILENAME3** and **dnload-cfgfileX= FILENAME 4**, the OLT reports an error because the filenames are not the same.

e. Configure equipment interface **pland-cfgfile1=XMLXXXXXX1** and **dnload-cfgfile1 XMLXXXXXX1**

Configure equipment interface **pland-cfgfile2=XMLXXXXXX2** and **dnload-cfgfile2 XMLXXXXXX2**

Although the OLT permits the above two steps without reporting an error, Nokia does not recommend executing them, because the ONT may exhibit unexpected behavior.

f. If **pland-cfgfileX=Auto** and **dnload-cfgfileX= Auto**

The OLT will download the XML file from "sw-ctr-list" (**configure equipment ont sw-ctrl**)

---

**END OF STEPS**

The ONT will distribute the configuration files to the different services based on the active indication from the OLT and on the Nokia defined index.

The ONT automatically reboots to apply the configuration files. After the ONT reboots and reports the active version, the OLT completes the file download procedure.

Operators must check the committed file from the OLT to verify whether the corresponding file has been applied. If an error occurs, contact Nokia for support.