

1 Factory default settings

CAUTION

Failure to follow these instructions could result in damage to the product and void the factory warranty.
The accuracy of the door preparation is critical for the proper functioning and security of this product. Misalignment can cause performance degradation and a lessening of security.

NOTES

- Master PIN code: Default master PIN code is "12345678", please modify it after installation.
- User PIN code number: User PIN codes can be set up with PIN code numbers.
00-04: Normal user PIN code number.
05-08: Temporary user PIN code number. It will be deleted automatically after one time use.
- Emergency PIN code: Under threatening situation, it will send alarm signals to other users.
- User PIN code: User PIN codes can be set up only through master PIN code. Each PIN code has only one PIN code number.
- Card: Maximum 100 cards can be registered with card numbers(00-99).
- Fingerprint: Maximum 100 fingerprints can be registered with fingerprint numbers(00-99).
- Please refer to below item numbers in manual to set up the product with master PIN code and use it.

Model	How to open	How to set up
KB-1	6.1.1. PIN code	5.1. Add user PIN code
	6.1.2. Fingerprint	5.2. Add user fingerprint
		5.3. Add user card
KB-5	6.1.1. PIN code	5.4. Delete user PIN code
	6.1.2. Fingerprint	5.5. Delete user fingerprint
	6.1.3. Card	5.6. Delete user card

Components

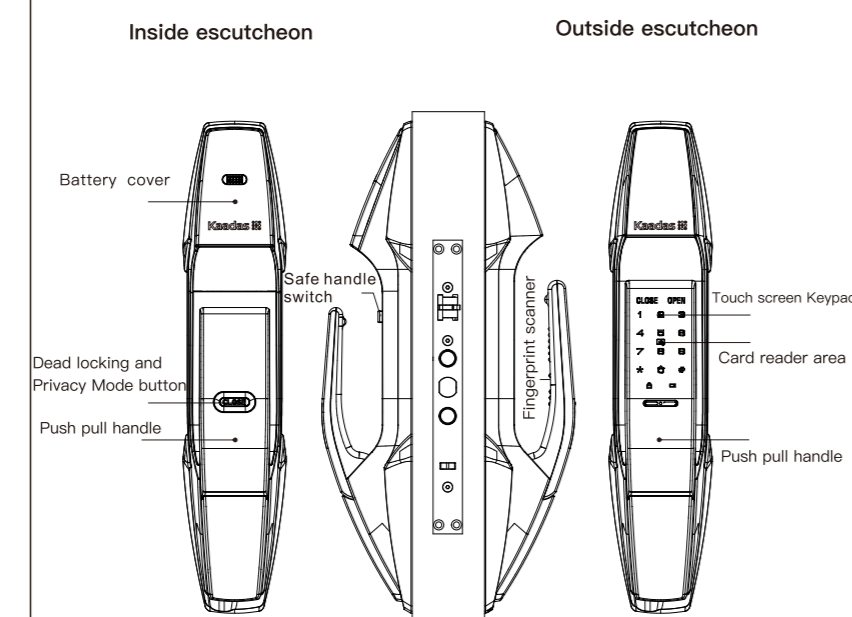

1 Bottom of outside escutcheon

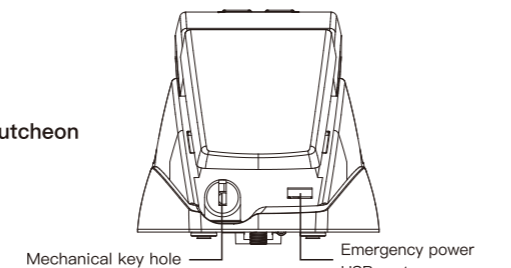

2 Lock case

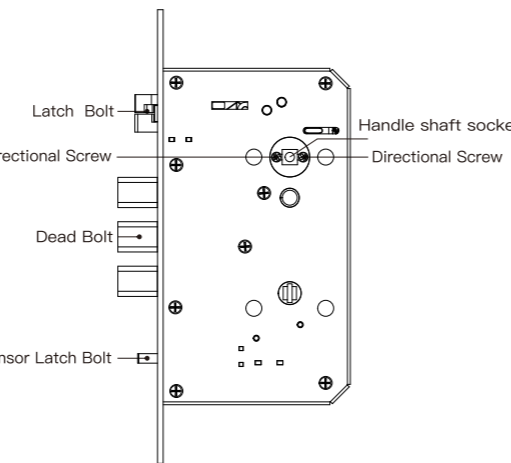

3 Mechanical Key

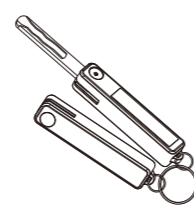

NOTE

Pictures of components above are just for reference. They can be different according to your model.

2 Packing list and explosive view

Please check all parts carefully according to the following list after opening the box.

Number	Item name	Quantity	Remark
1	Outside escutcheon	1	
2	Inside escutcheon	1	
3	Lock case	1	
4	Screw package	1	
5	User manual	1	
6	Warranty card	1	
7	Mechanical key box	1	2 pieces of Emergency Key
8	Strike plate and plastic case	1	
9	Installation template	1	
10	Inside mounting plate	1	
11	User card	2	(optional)
12	Network module	1	(optional)

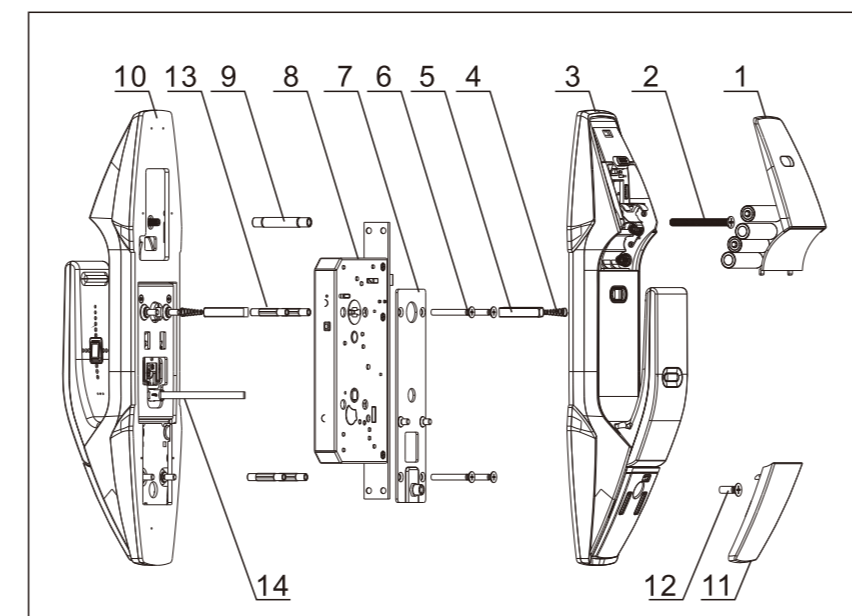

- Battery cover
- Through bolt of inside escutcheon
- Inside escutcheon
- Handle shaft spring
- Handle shaft
- Inside mounting plate screw
- Inside mounting plate
- Lock case
- Through bolt guide
- Outside escutcheon
- Screw hole cover
- Inside escutcheon mounting screw
- Inside mounting plate screw guide
- Cylinder key tailpiece

3 Prepare lock for installation

- Confirm door direction
This product can be installed depending on 4 types of door directions.

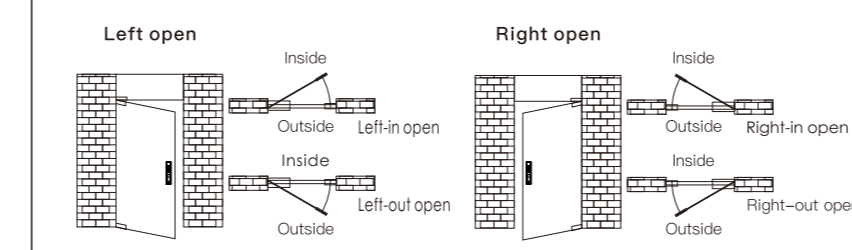

2 Confirm door thickness

- Measure your door thickness and confirm the screw package fits your door.
- Factory default screw package is for 40-60mm door thickness. If it doesn't fit your door, please contact our dealer.

3 Change direction of pull push handle

Please change the position of screws and fix them according to the door direction.

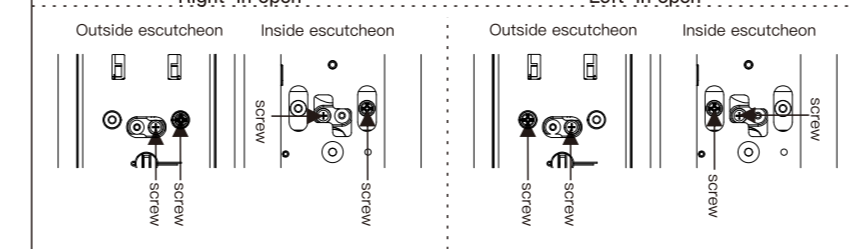

4 Fix directional screws

Change side of directional screws.

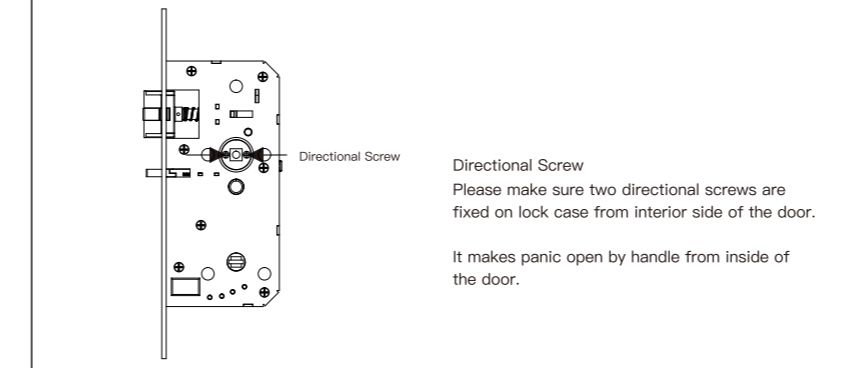

4 Installation

- Drill holes according to the installation template, and put the top case inside the door.

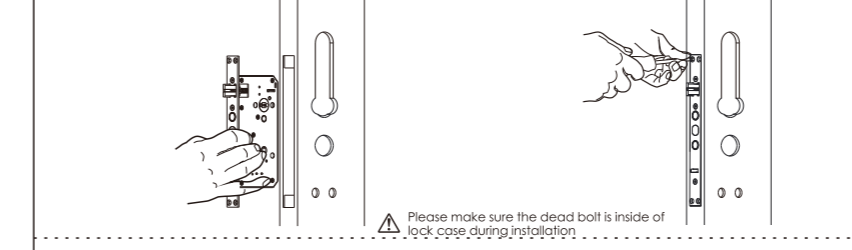

2 Install the through bolt guide and fix it on the outside escutcheon, put the shaft spring and shaft into the hole.

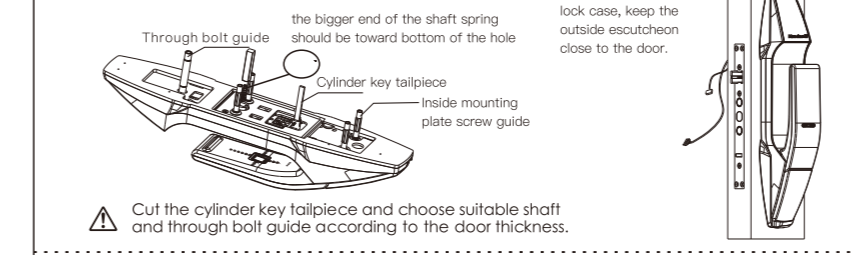

4.5 Fix the inside mounting plate with screws.

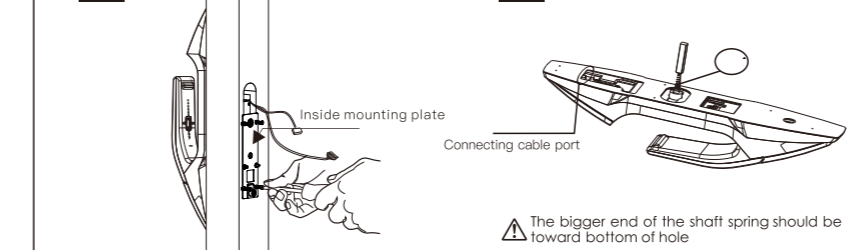

4.7 Insert the connecting cable and lock case cable into the port on inside escutcheon. Then insert the shaft of handle escutcheon into the hole on the lock case and the escutcheon closes to the door.

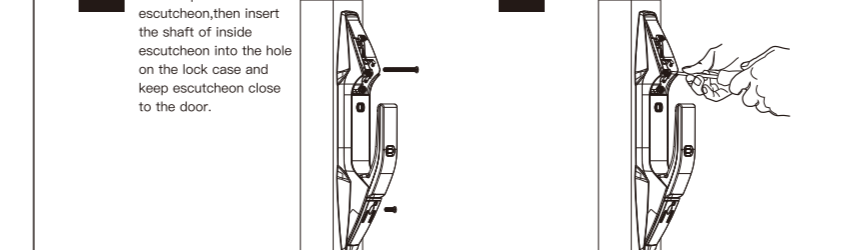

4.9 Install batteries, battery cover, screw hole cover and strike plate.

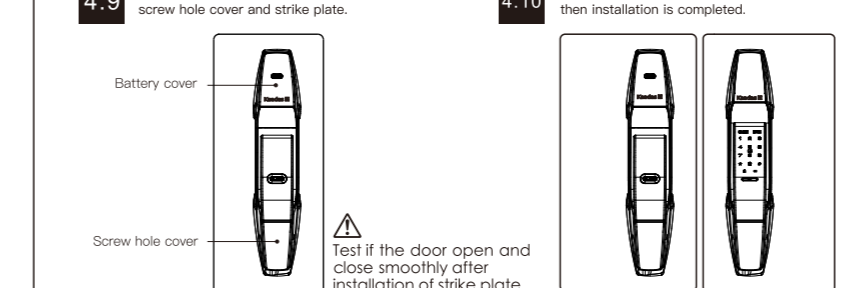

5 How to set up product

5.1 How to enter Master Mode

- Wake up Touchscreen keypad with palm.
- Press [1] twice, input Master PIN code, and press [E] to confirm.
- Voice guide: Enter the Master Mode.

5.2 Menu index in Master Mode

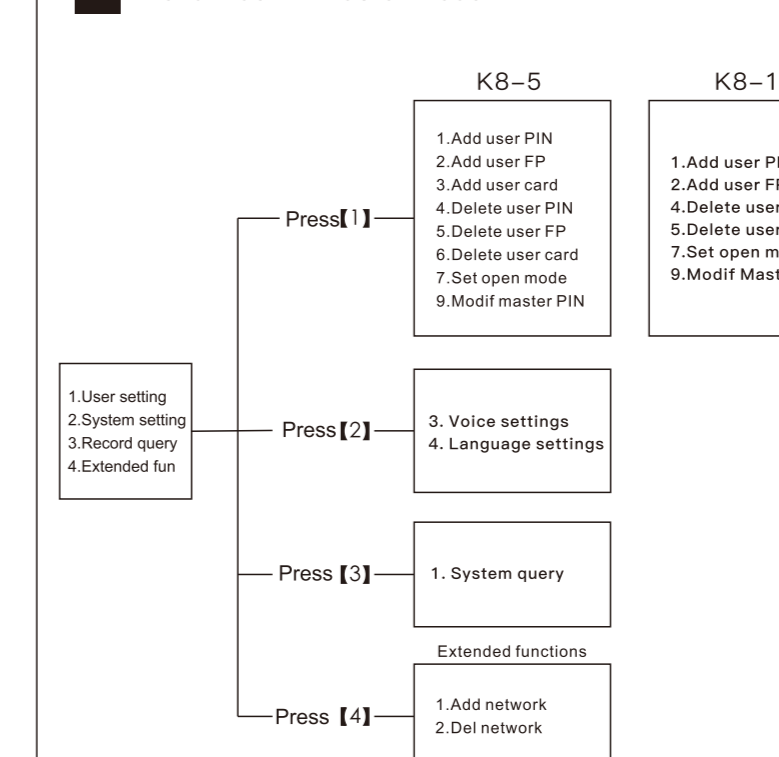

NOTE

- You can operate following the voice guide.
- Master and User PIN code have 6-12 digits, the default Master PIN is [12345678].
- Input [100#] to check product serial number.

User Setting

Add user PIN code

- Enter Master Mode, and press [1] enter user settings press [1] to add user PIN code.
- Input user PIN code number(00-99), press [E] to confirm.
- Input 6-12 digits of user PIN code and press [E] to confirm, Voice guide: add succeeded.

User PIN code number: User PIN codes can be set up with PIN code numbers.
00-04: Normal user PIN code number. It will be deleted automatically after one time use.
05-08: Temporary user PIN code number. It will send alarm signals to other users.

Add user fingerprint

- Enter Master Mode(refer to item 5.1), press [1] into user settings, press [2] to add user fingerprint.
- Input fingerprint number(00-99), press [E] to confirm.
- Put finger on the fingerprint scanner 4 times according to voice guide. Voice guide: Please remove your finger and scan again. 2.Add succeeded.

Fingerprint number: fingerprint can be registered with fingerprint numbers.
00-99: Normal fingerprint number
95-99: Emergency fingerprint numbers. Under threatening situation, it will send alarm signals to other users.

Add user cards

- Enter Master Mode(refer to item 5.1), press [1] into user settings, press [3] to add user card.
- Input card number(00-99), press [E] to confirm.
- Put card close to card reader area until hear the sound "d!". Voice guide: Add succeeded.

纸张: 128g铜版纸双面单黑印刷

工艺: 风琴7折, 折后尺寸125*265mm

Delete user PIN code

- 1 + 4** Enter Master Mode(refer to item 5.1), press [1] to enter user setting, press [4] to delete user PIN code.
- 1** Press [1] for deleting single PIN code.
- 1 2 3 4 5 6 7 8 9 #** Input PIN code number that you want to delete, press [#] to confirm. Voice guide: Deletion succeed.
- 2** Press [2] for deleting all PIN codes. Voice guide: Deletion succeed.

Delete user fingerprint

- 1 + 5** Enter Master Mode(refer to item 5.1), press [1] to enter user setting, press [5] to delete user fingerprint.
- 1** Press [1] for deleting single fingerprint.
- 1 2 3 4 5 6 7 8 9 #** Input fingerprint number that you want to delete, press [#] to confirm, or put the finger on the fingerprint scanner until hearing the sound "di". Voice guide: Deletion succeed.
- 2** Press [2] for deleting all fingerprints. Voice guide: Deletion succeed.

Delete user card(optional function)

- 1 + 6** Enter Master Mode(refer to item 5.1), press [1] to enter user setting, press [6] to delete user card.
- 1** Press [1] for deleting single card.
- 1 2 3 4 5 6 7 8 9 #** Input card number that you want to delete, press [#] to confirm, or put the card on the card reader area until hearing the sound "di". Voice guide: Deletion succeed.
- 2** Press [2] for deleting all cards. Voice guide: Deletion succeed.

Set up open mode

- 1 + 7** Enter Master Mode(refer to item 5.1), press [1] to enter user setting, press [7] to set up open mode.
- 1** Press [1] to choose normal mode, Opening way: PIN code, fingerprint or card.
- 2** Press [2] to choose safe mode: PIN code+fingerprint (PIN code+card or fingerprint+ card) double verification.

NOTES Under safe mode, the operation of "deleting all" can't be done.

Modify master PIN code

- 1 + 9** Enter Master Mode(refer to item 5.1), press [1] to enter user setting, press [9] to modify master PIN code.
- 1 2 3 4 5 6 7 8 9 #** Input new master PIN code (6-12 digits), press [#] to confirm and input new PIN code again, press [#] to confirm. Voice guide: setting succeed.

NOTES Please modify master PIN code after installation.

System Settings

Voice settings

- 2 + 3** Enter Master Mode(refer to item 5.1), press [2] to enter System Settings, press [3] to enter voice settings.
- 1** Press [1] to set up operating sound on, then product will provide operating sound.
- 2** Press [2] to set up operating sound off, then system won't provide operating sound except alarm and voice guide in Master Mode.

Language setting

- 2 + 4** Enter Master Mode(refer to item 5.1), press [2] to enter System Settings, press [4] to enter language setting.
- 1** Press [1] to choose Chinese, then the voice guide will be in Chinese.
- 2** Press [2] to choose English, then the voice guide will be in English.

System Query

Serial number Query

- 3** Enter Master Mode(refer to item 5.1), press [3] to enter System Query.
- 1** After entering System Query, press [1], then the serial number of lock will be read.

* You can also check your serial number by inputting 400+[#].

6 How to use your product

6.1 Under Normal Mode

6.1.1 PIN code opening

1. Wake up keypad with your palm, Input added User PIN code, press [#] to confirm. Voice guide "Verification succeed".
2. Push or pull handle to open the door.
- NOTE** Users can input fake PIN code before or after correct user PIN code(the input PIN code can't be over 20 digits including fake PIN code).

6.1.2 Fingerprint opening

1. Put finger(added) on the fingerprint scanner, Voice guide: "Verification succeed" after hearing the sound "di".
2. Push or pull handle to open the door.

6.1.3 Card opening(Optional function)

1. Put card(added) on the card reader area, voice guide: "Verification succeed" after keypad lighting up and hearing the sound "di".
2. Push or pull handle to open the door.

6.2 Under Safe Mode Under Safe Mode, It needs double verification to open the door.

- (1)PIN code+fingerprint
(2)PIN code+card
(3)Fingerprint+card

6.3 Mechanical key opening

6.3.1 mechanical key cylinder

- When meeting emergency of forgetting PIN code, power down or system error, you can use mechanical key to open the door.
- Open the cover on Outside escutcheon, then insert the mechanical key into the keyhole and turn the key, after that you can push or pull the handle to open the door.

6.4 Automatic/Manual Mode

1. Remove battery cover, you will see an A-M switch.
2. "A" means Automatic Mode: after closing door, dead bolts will stretch out automatically, and the door will be locked.
3. "M" means Manual Mode: after closing door, dead bolts will not stretch out, the door will keep opening.

6.5 Dead locking and Privacy Mode button

1. Press "CLOSE" button: main bolts will stretch out immediately to lock the door no matter the lock is in Automatic Mode or Manual Mode when the door is closed.
2. Hold "CLOSE" button: when the door is in closed state, no matter the lock is in Automatic or Manual Mode, the main bolt will stretch out to lock the door immediately and enter the Privacy Mode. In this state the lock could be opened only by mechanical key from outside and it will relieve the limitation after opening the door from inside or using mechanical key.

* Emergency opening: Double click "CLOSE" button to unlock the door when the door can not be opened by push/pull handle from inside.

6.6 Dead locking

6.6.1 Dead locking from outside

Dead bolts will stretch out in 1.5 second after door closed when the lock is in Automatic Mode. Voice guide: "Door closed".

6.6.2 Dead locking from inside

Press "CLOSE" to dead lock the door when the lock is in Manual Mode. Voice guide: "Door closed".

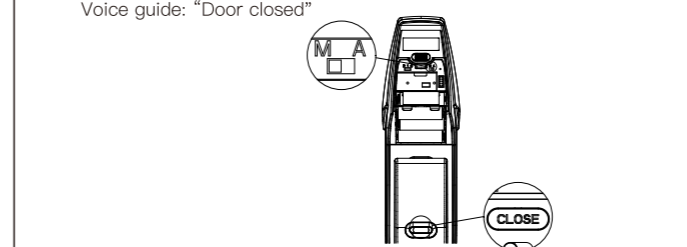

6.6.3 Privacy Mode

Hold "CLOSE" button to enter Privacy Mode, voice guide: "Privacy Mode on", it need to be opened from inside or from outside with mechanical key.

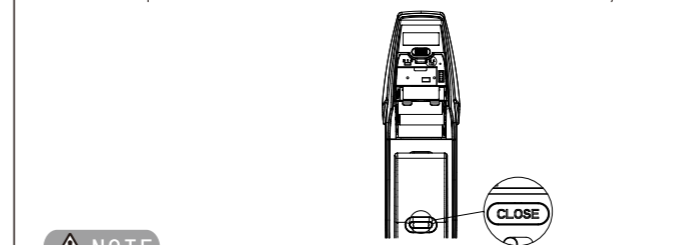

NOTE 1. In normal mode, if continuously inputting wrong PIN code or fingerprint or card 10 times, the touchscreen keypad will be locked for 5 minutes. Under this condition, you can exit it by take out the battery and put them back, or you can open the door with other ways.

2. In safe mode, continuously inputting any two kinds of opening ways among password/fingerprint/card 10 times, the system will be locked for 5 minutes. Under this condition, password/fingerprint/card can't be inputted.

you need to take batteries out and put them back to unlock the system.

NOTE 1. ON: After closing the door from outside, keypad lights up, press "0", voice guide: "Defense ON", the lock will alarm when someone open the door from inside.

2. OFF: Defense mode will remove once there are someone open the lock in any ways from outside.

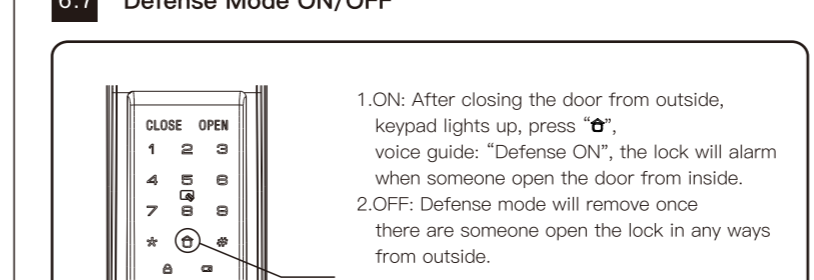

NOTE When the power is lower than 4.5V, system will sound voice guide: "Low power, please replace the battery" after every time you open the lock successfully. In this situation, please change batteries ASAP. (do not use different types of batteries together or old and new batteries together).

6.6 Safe handle

1. When you see red in switch, it means safe handle function has been activated, in this condition, the inside handle can't pushed or pulled and the door can be opened only from outside.

2. When you see green in switch, it means safe handle function has been closed, in this condition, the inside handle can be pushed or pulled freely and the door can be opened from both side of the door.

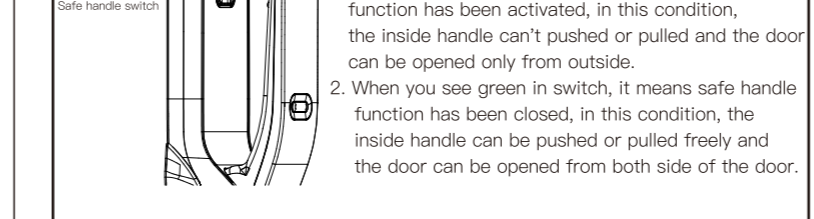

6.9 Volume adjusting

1. You will see "0-1-2" toggle switch after removing battery cover.
2. When the switch is at "0", the lock is in mute state (alarm and voice are excepted).
3. When the switch is at "1" or "2", all the sound is on. Bigger the setting number is, volume will be louder.

NOTES When waking up keypad from outside, press [#] before inputting user PIN code, there will be temporary no sound. [#] user PIN code[#].

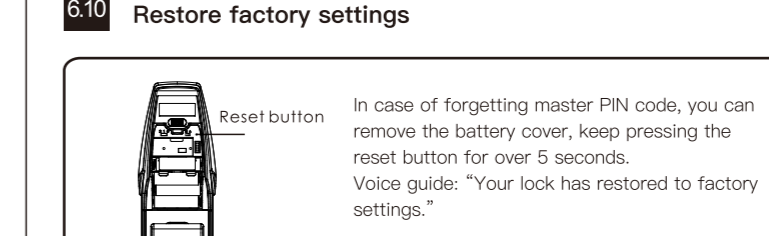

6.10 Restore factory settings

- Reset button
- In case of forgetting master PIN code, you can remove the battery cover, keep pressing the reset button for over 5 seconds. Voice guide: "Your lock has restored to factory settings."
- It means the lock has been restored to factory settings successfully.

NOTES All the PIN codes/fingerprints/cards added before will be cleared after restore to factory settings. The master PIN code will restore as [12345678]. Please modify master PIN code as soon as possible.

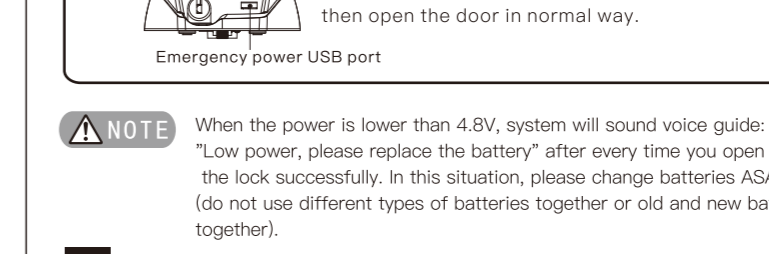

6.11 How to use emergency power USB port

- Emergency power USB port
- If the batteries are wearing out, you can connect Micro-USB 5V provide power. Insert the cable into the Emergency power USB port, then open the door in normal way.

NOTE When the power is lower than 4.5V, system will sound voice guide: "Low power, please replace the battery" after every time you open the lock successfully. In this situation, please change batteries ASAP. (do not use different types of batteries together or old and new batteries together).

6.12 How to change batteries

1. Battery life
- In the battery box you can put 8 AA 1.5V alkaline batteries maximum. It can be used for over one year as the standard used 10 times a day. (Battery life is relative to user's using habits, using environment, optional function and so on.)
2. Voice guide of replacing batteries
- When hearing "Low power, please replace the battery", please change batteries as soon as possible.



6.13 Emergency 9V battery port

- Emergency power port
- If the batteries were wearing out, you can use a 9V battery as emergency power. Connect the two electrode with port on Outside escutcheon, then open the door in normal way.

6.14 Reboot button

- Reboot button
- If product system halted or ringing without any reason, you can use a stick press on Reboot button until hearing sound "di" to reboot the product.

6.15 Extended functions

- Extended functions could be activated by network module.
- Please contact our dealer for more details.

NOTE Do not put your hand on the side of handle which is close to the doorframe when you are closing the door by put the handle, it may hurt your hand. Please put your hand on the side of handle which is away from doorframe or the upper end of the handle. Right operation as follows:

